

SURGICAL 2024-25



CATALOGUE

NST ZONE
Manufacturers of Surgical Instruments



Scissors Family



Forceps Family

Company's Profile

We feel pleasure to be in correspondence for the purpose of our company's introduction **NST ZONE**. We are manufacturer of all types of Surgical Instruments and are designed & made with state of art, according to International Standards especially for **Europe, USA and Asia**.

✓••Our company is ISO 9001:2008 ,ISO:13485:2003, CE Marking.

✓••Our Company is exporting Beauty Instruments and shears in USA, Europe, and The Great Britain.

✓••Our Instruments and Shears are made of stainless steel with all specifications of world standard

Stainless steel grade used for scissors 410 or 420 and 440C SS

✓••We do enclose the laboratory reports with the shipment.

We are extremely careful concerning:-

- The selection of stainless steel
- The finishing treatment and durability of reusable shears efficacy.

PRODUCTS & GUARANTEE

Our products carry sufficient guarantees under the terms of which we will replace them if we consider being imperfect all out of order unless miss handled/used by the end user.

Philosophy:

Beside of constant diversification, innovations for Professional Instruments and new product development, the production facilities in the manufacturing, have been in line with the permanent growing demands and requirements. The producing follows with modern machinery and plants, combined with long lasting experience and craftsman know-how. In spite of exertion of latest product engineering the traditional handcraft still needs and is also an important quality-attribute. Accepted are only exclusively high-grade steels and materials.

❖••Product quality and customer satisfaction are the primary aims/objects of the company.

❖••Our Company could provide you samples free of cost as a matter of our company's policy

TECHNICAL ILLEGIBILITY

Our Company is equipped with latest and advanced Machinery including:-

✓••Automatic Vibrator Polishing system Units



FDA, CE, ISO 9001:2008
ISO 13485:2012 CE Class I
FDA (CGMP)

- ✓••Ultra sonic cleaning system
- ✓••Heat treatment / Tempering system For stainless steel AISI410-AISI 420-AIS440
- ✓••Latest lathe/Shaper and Grinding Machines
- ✓••Latest cutting machines and shears
- ✓•• Polishing system.
- ✓••Shapers
- ✓••Passivation's of the instruments for avoiding the corrosion / rusting in the later stage.

INSPECTION & TESTING LAB

We have latest Lab for testing the following:-

- Material Test
- Hardness Test
- Boiling & Passivation
- Copper Sulphate (CuSO₄) test.
- Final products analysis test.

Final products analysis test.

COMPLETE RANGE OF BELOW CATEGORIES

- Specialized Single Use instruments (Non Sterile & Sterile)
- Surgical Reusable Instruments
- Dental Instruments Reusable & Single Use (Non Sterile & Sterile)
- Mesh Trays & Baskets
- Hollowware Instruments
- Diagnostics Instruments
- New Product Sterile & Non-Sterile Single Use Kits

PRODUCTION CAPABILITY

- We have enough capability of producing 300000 to 400000 Instruments per Month.



Scissors Family



Straight

Standard
Fig. 1

10.0	cm/4"	05-1401-10
11.5	cm/4½"	05-1401-11
13.0	cm/5"	05-1401-13
14.5	cm/5¾"	05-1401-14
15.5	cm/6"	05-1401-15
16.0	cm/6¼"	05-1401-16
18.0	cm/7"	05-1401-18
20.0	cm/8"	05-1401-20



Straight

Standard
Fig. 2

05-1402-10
05-1402-11
05-1402-13
05-1402-14
05-1402-15
05-1402-16
05-1402-18
05-1402-20



Straight

Standard
Fig. 3

05-1403-10
05-1403-11
05-1403-13
05-1403-14
05-1403-15
05-1403-16
05-1403-18
05-1403-20



Curved

Standard
Fig. 1

10.0	cm/4"	05-1404-10
11.5	cm/4½"	05-1404-11
13.0	cm/5"	05-1404-13
14.5	cm/5¾"	05-1404-14
15.5	cm/6"	05-1404-15
16.0	cm/6¼"	05-1404-16
18.0	cm/7"	05-1404-18
20.0	cm/8"	05-1404-20



Curved

Standard
Fig. 2

05-1405-10
05-1405-11
05-1405-13
05-1405-14
05-1405-15
05-1405-16
05-1405-18
05-1405-20



Curved

Standard
Fig. 3

05-1406-10
05-1406-11
05-1406-13
05-1406-14
05-1406-15
05-1406-16
05-1406-18
05-1406-20



Grazi

05-1407-13	13.0 cm/5"	05-1408-13
05-1407-14	14.5 cm/5 3/4"	05-1408-14
Straight		



Grazi

05-1409-13	13.0 cm/5"	05-1410-13
05-1409-14	14.5 cm/5 3/4"	05-1410-14
Curved		



Straight

05-1411-14



Curved

Deaver
14.5cm/5 3/4"

05-1412-14



Straight

05-1413-15



Curved

Mixer
15.5cm/6"

05-1414-15



Lexer
Straight
05-1415-16
16 cm/6 1/4"



Lexer
Curved
05-1416-16
16 cm/6 1/4"



Lexer-Fine
Straight
05-1417-16
16 cm/6 1/4"



Lexer-Fine
Curved
05-1418-16
16 cm/6 1/4"

Incision Scissors



05-1419-13 13.0 cm/5 1/4"
05-1419-14 14.5 cm/5 3/4"



05-1420-15
15.5 cm/6"



Richter
05-1421-14
14.5 cm/5 3/4"



Richter
05-1422-14
14.5 cm/5 3/4"



**Mayo
Straight**
05-1423-14 14.5 cm/5 3/4"
05-1423-15 15.0 cm/6"
05-1423-17 17.0 cm/6 3/4"
05-1423-19 19.0 cm/7 1/2"
05-1423-23 23.0 cm/9"



**Mayo
Curved**
05-1424-14 14.5 cm/5 3/4"
05-1424-15 15.0 cm/6"
05-1424-17 17.0 cm/6 3/4"
05-1424-19 19.0 cm/7 1/2"
05-1424-23 23.0 cm/9"



**Mayo-Stille
Straight**
05-1425-15 15 cm/6"
05-1425-17 17 cm/6 3/4"
05-1425-19 19 cm/7 1/2"
05-1425-21 21 cm/8 1/4"



**Mayo-Stille
Curved**
05-1426-15 15 cm/6"
05-1426-17 17 cm/6 3/4"
05-1426-19 19 cm/7 1/2"
05-1426-21 21 cm/8 1/4"



Fergusson
05-1427-18
18 cm/7"



New Suture
05-1428-14
14.5 cm/5 3/4"



Straight

Mayo-Noble
05-1429-17
17 cm/6 3/4"



Curved

Mayo-Noble
05-1430-17
17 cm/6 3/4"



Straight



Fig 1 **Metzenbaum** 05-1431-14 14.5 cm/5¾"
 Fig 2 **Metzenbaum** 05-1432-14 14.5 cm/5¾"
 Fig 3 **Metzenbaum** 05-1433-14 14.5 cm/5¾"

Straight

Curved

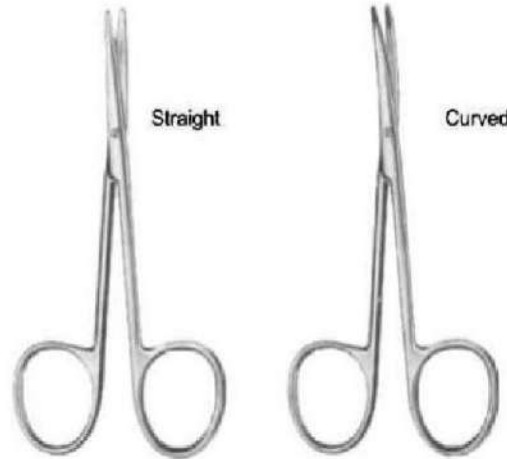

Baby-Metzenbaum 05-1434-11 11.5 cm/4½"
Baby-Metzenbaum 05-1435-11 11.5 cm/4½"

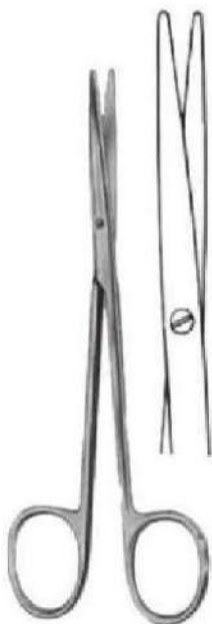

Metzenbaum-Fine 05-1436-14 14.5 cm/5¾"

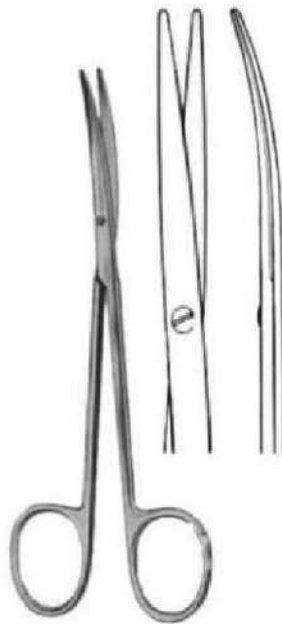

Metzenbaum-Fine 05-1437-14 14.5 cm/5¾"



Metzenbaum-Fine 05-1438-14 14.5 cm/5¾"

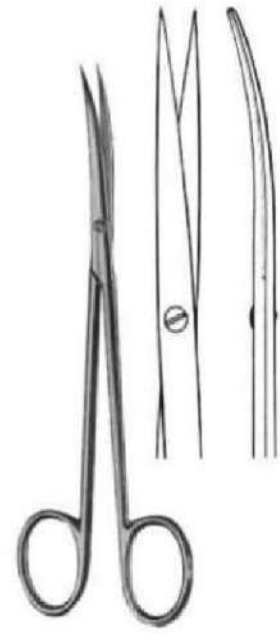

Metzenbaum-Fine 05-1439-14 14.5 cm/5¾"



Straight



Metzenbaum-Fine

18 cm/7"
20 cm/8"
23 cm/9"
25 cm/10"
28 cm/11"
30 cm/12"

05-1440-18
05-1440-20
05-1440-23
05-1440-25
05-1440-28
05-1440-30



Metzenbaum

05-1441-18
05-1441-20
05-1441-23
05-1441-25
05-1441-28
05-1441-30



Metzenbaum

05-1442-18
05-1442-20
05-1442-23
05-1442-25
05-1442-28
05-1442-30



Metzenbaum

05-1443-18
05-1443-20
05-1443-23
05-1443-25
05-1443-28
05-1443-30



Sims

05-1444-20 20 cm/8"
05-1444-23 23 cm/9"



Straight

05-1445-20 20 cm/8"
05-1445-23 23 cm/9"



05-1446-20
05-1446-23



Sims

05-1447-20 20 cm/8"
05-1447-23 23 cm/9"



Curved

05-1448-20 20 cm/8"
05-1448-23 23 cm/9"



05-1449-20
05-1449-23



Curved

Dubois
05-1450-27 27 cm/10 1/2"



Dubois
05-1451-27 27 cm/10 1/2"



Straight

Doyen
05-1452-16 16 cm/6 1/4"
05-1452-18 18 cm/7"



Curved

Doyen
05-1453-16 16 cm/6 1/4"
05-1453-18 18 cm/7"



Kelly
05-1454-16 16 cm/6 1/4"
05-1454-18 18 cm/7"



Kelly
05-1455-16 16 cm/6 1/4"
05-1455-18 18 cm/7"



Fig. 1
05-1456-12



Fig. 2
05-1457-12

Straight



Fig. 3
05-1458-12

12cm/4¾"



Fig. 1
05-1459-12



Fig. 2
05-1460-12

Curved



Fig. 3
05-1461-12

12cm/4¾"

Saw Edge



Wagner
12cm/4¾"

Curved



Fig. 1
05-1462-12



Fig. 2
05-1463-12



Fig. 3
05-1464-12



Fig. 4
05-1465-12



Fig. 1
05-1466-12



Fig. 2
05-1467-12



Fig. 3
05-1468-12



Fig. 4
05-1469-12

Straight



05-1470-12
11.5cm/4½"

Curved



05-1471-12
11.5cm/4½"



Straight

Brophy (Sullivan)
05-1472-14

14.5 cm/5 3/4"

05-1473-14



Curved



Straight

Reynolds
05-1474-15
05-1474-18

15 cm/6"
18 cm/7"



Curved

05-1475-15
05-1475-18

Enucleation Scissors



Jameson
05-1476-15
15cm/6"



05-1477-12



05-1478-12



Landolt
12.5cm/5"

05-1479-12



05-1480-12



9.0 cm/3½"	05-1481-09	05-1482-09	05-1483-09	05-1484-09	05-1485-09
10.5 cm/4½"	05-1481-10	05-1482-10	05-1483-10	05-1484-10	05-1485-10
11.5 cm/4½"	05-1481-11	05-1482-11	05-1483-11	05-1484-11	05-1485-11

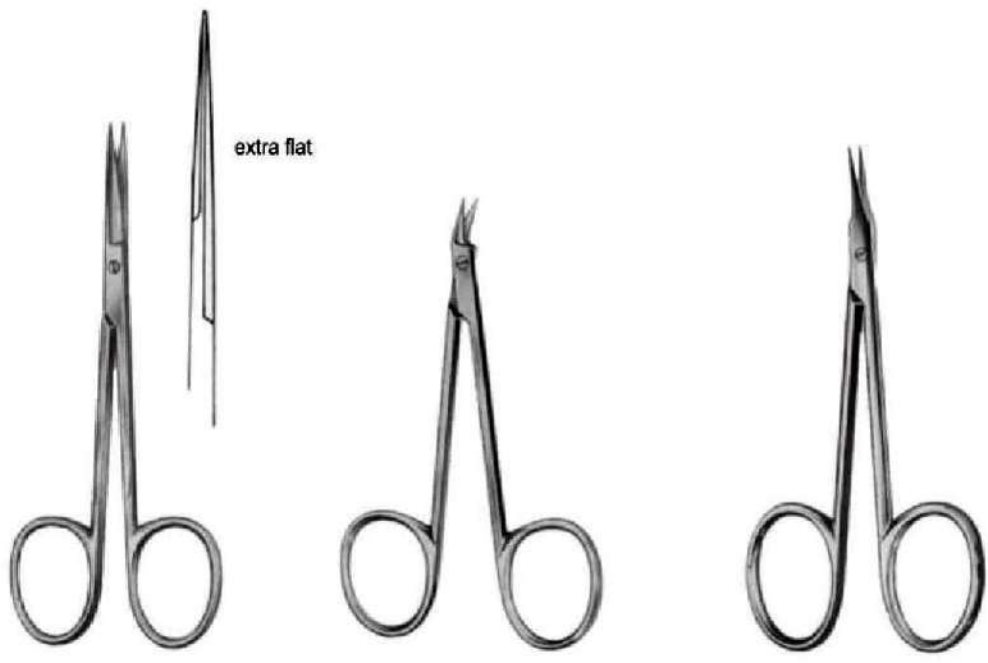

05-1486-10
10cm/4"

05-1487-09
9cm/3½"

Walton
05-1488-10
10cm/4"



Straight

05-1489-14

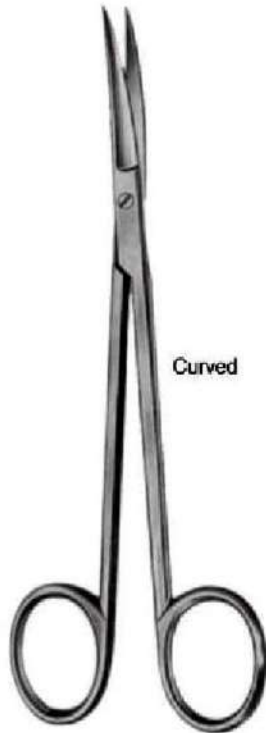

Curved

05-1490-14

Sanvenero
14.5cm/5¾"



Straight

05-1491-10

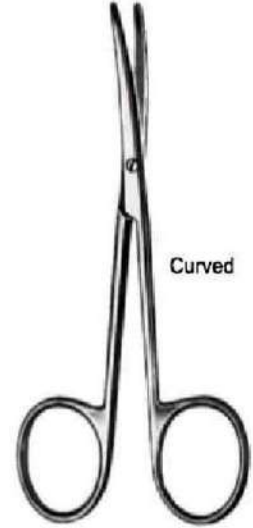

Curved

05-1492-10

Baby-Lexer (Knapp)
10cm/4"



Straight
05-1493-13 13cm/5"

Curved
05-1494-13

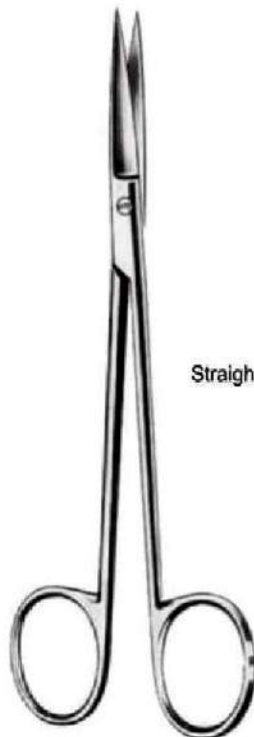

Straight

05-1495-14

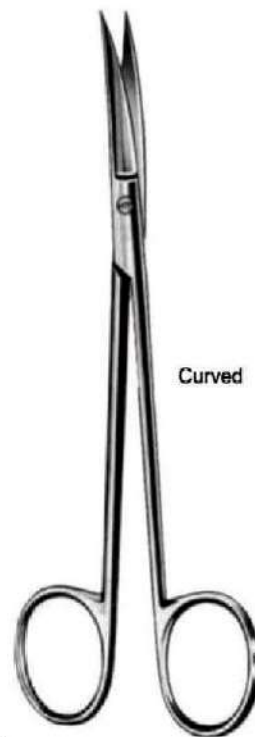

Curved

Joseph
14cm/5½"

05-1496-14



Kilner (Ragnell)
05-1497-12 12cm/4 3/4"
05-1497-13 13cm/5"
05-1497-15 15cm/6"



Coronary Scissors

05-1498-14
14.5cm/5 3/4"



05-1499-11
11.5cm/4 1/2"



Potts-Smith
05-1500-19
19.5cm/7 3/4"



De Bakey
05-1501-15
15.5cm/6"



De Bakey
05-1502-15
15.5cm/6"



Favaloro
05-1503-15
15cm/6"

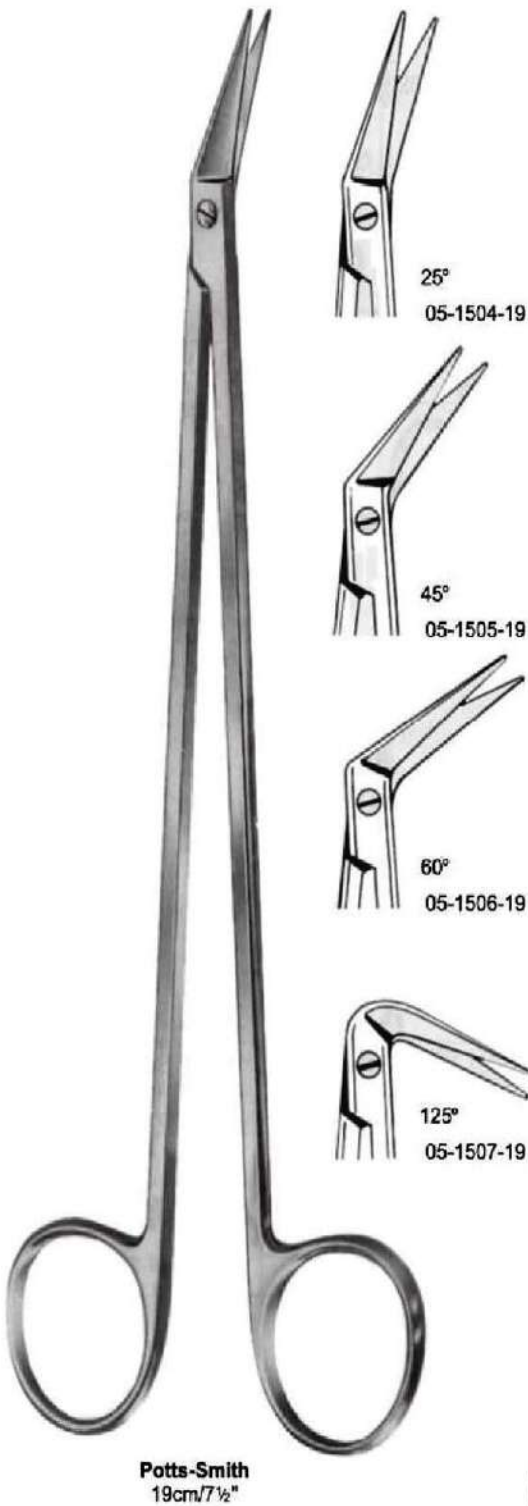



De Bakey
18cm/7"

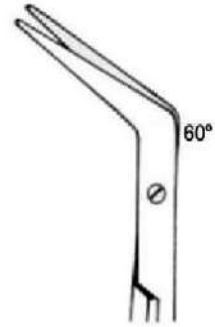
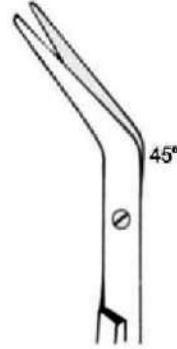
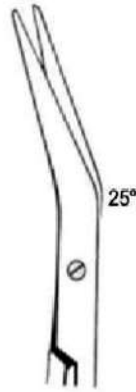

cm	In			
16.0cm	6 1/4"	05-1512-16	05-1513-16	05-1514-16
23.0cm	9"	05-1512-23	05-1513-23	05-1514-23
28.0cm	11"	05-1512-28	05-1513-28	05-1514-28



Baby-Hegemann
13.5cm/5 1/4"

Hegemann (Diethrich)
16cm/6 1/4"
19cm/7 1/2"

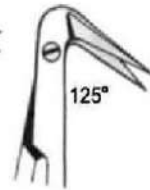
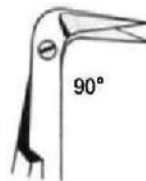
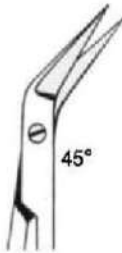

cm	In					
13.0cm	5 1/4"	05-1515-13	05-1516-13	05-1517-13	05-1518-13	05-1519-13
16.0cm	6 1/4"	05-1515-16	05-1516-16	05-1517-16	05-1518-16	05-1519-16
19.0cm	7 1/2"	05-1515-19	05-1516-19	05-1517-19	05-1518-19	05-1519-19



Hegemann (Diethrich)
05-1520-19
19cm/7 1/2"



Nerve Dissecting Scissors



05-1521-15
15cm/6"

Tonsil Scissors



Bottcher
05-1522-18
18cm/7"



Prince
05-1523-17
17.5cm/7"

Arteriotomy Scissors



Tonnis-Adson-Fine
05-1524-17
17.5cm/7"

Straight



Tonnis
05-1525-18
18cm/7"

Curved



Tonnis
05-1526-18
18cm/7"



Tonnis-Adson
05-1527-17
17.5cm/7"



Tonsil Scissors



Good
05-1528-19
19 cm/7 1/2"

Lobectomy Scissors



Crafoord
05-1529-30
30 cm/12"



Finochietto
05-1530-27
27 cm/10 1/2"

Enterotomy Scissors



05-1531-21
21 cm/8 1/4"



05-1532-21
21 cm/8 1/4"



05-1533-21
21 cm/8 1/4"



Busch
05-1534-13 13 cm/5"
05-1534-16 16 cm/6 1/4"



Schumacher
05-1535-16
16 cm/6 1/4"



Mod. USA
05-1536-10
10.5 cm/4 1/4"



Braun-Stadler
05-1537-14
14 cm/5 1/2"



Braun-Stadler
05-1538-22
22 cm/8 1/2"



Straight
05-1539-12

12cm/4 3/4"



Curved
05-1540-12



Heymann
05-1541-18
18 cm/7"



Heymann
05-1542-19
19.5 cm/7¾"



Knight
05-1543-18
18 cm/7"



Fomon
05-1544-13
13 cm/5"



Fomon
05-1545-13
13.5 cm/5¼"



Fomon
05-1546-13
13.5 cm/5¼"



Cottle
05-1547-16
16 cm/6¼"



Halle
05-1548-19
19 cm/7¼"



Strully
05-1549-22 22 cm/8¾" 05-1550-22



Dandy
05-1551-22
17 cm/6¾"



Trigeminal Scissors

15 cm/6"

Olivecrona
05-1552-15



11.5cm/4½"

Straight



05-1553-11



05-1554-11

Curved



05-1555-11



05-1556-11



Knapp
10.5cm/4¼"

Straight



05-1557-10



05-1558-10



05-1559-10

Curved



05-1560-10



05-1561-10



05-1562-10



Straight

Curved

Standard

9.0 cm/3½"	05-1563-09	05-1564-09	05-1565-09	05-1566-09
10.5 cm/4¼"	05-1563-10	05-1564-10	05-1565-10	05-1566-10
11.5 cm/4½"	05-1563-11	05-1564-11	05-1565-11	05-1566-11



Straight

Curved

Straight

Curved

Fine

Fine

9.0cm/3¾"			05-1569-09	05-1570-09
10.5cm/4½"	05-1567-10	05-1568-10	05-1569-10	05-1570-10
11.5cm/4½"	05-1567-11	05-1568-11	05-1569-11	05-1570-11



Straight
Fine

9.5 cm/3¾"	05-1571-09
10.5 cm/4¼"	05-1571-10
11.5 cm/4½"	05-1571-11



Curved
Fine

05-1572-09
05-1572-10
05-1572-11



Straight

05-1573-10 10cm/4"

Curved

05-1574-10

Tenotomy Scissors



10.5cm/4¼"
11.5cm/4½"



Pointed

Straight
05-1575-10
05-1575-11



Curved
05-1576-10
05-1576-11



Blunt

Straight
05-1577-10
05-1577-11



Curved
05-1578-10
05-1578-11

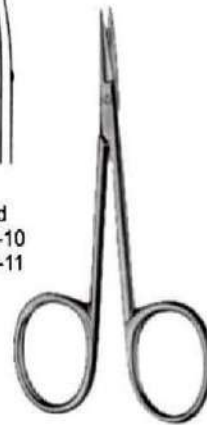

Straight
05-1579-08



Bonn 8cm/3¼"
Curved
05-1580-08



Graefe
05-1581-10
10.5cm/4¼"



Wilmer
05-1582-10
10cm/4"



05-1583-11



11.5cm/4½" 05-1584-11



La Grange
05-1585-11
11.5cm/4½"



Chadwick
05-1586-11
11cm/4½"

Neurosurgical Scissors



Straight

05-1587-11 11cm/4½"
05-1587-13 13cm/5"



Curved

05-1588-11
05-1588-13



Potts-de Martel
05-1589-21
21cm/8¼"



Mills
05-1590-21
21cm/8¼"



Dura Scissors

Schmieden-Taylor
05-1591-14 14.5cm/5¾"
05-1591-17 17.0cm/6¾"



05-1592-22
Strully
22cm/8¾"



05-1593-22



Dandy
05-1594-17
17cm/6¾"



Littauer
05-1595-14
14cm/5½"



Spencer
05-1596-09
9cm/3½"



Spencer
05-1597-10 10.5cm/4¼"
05-1597-12 12.0cm/4¾"



Spencer-Fine
05-1598-11 11.5cm/4½"
05-1598-16 16cm/6¼"



Shortbent
05-1599-09
9cm/3½"



Northbent
05-1600-12
12.5cm/5"



Spencer
05-1601-11
11.5cm/4½"



Littler
05-1602-11
11.5cm/4½"



Heath
05-1603-15
15cm/6"



05-1604-10
10cm/4"



Eiselsberg
05-1605-11
11.5cm/4½"



Schoemaker-Loth
05-1606-12
12.5cm/5"

Wire Cutting Scissors



Universal
05-1607-12
12cm/4¾"

Saw Edge



Universal
Black 05-1608-01
Blue 05-1608-02
Red 05-1608-03
Green 05-1608-04

14.5 cm/5 3/4"



Universal
05-1609-01
05-1609-02
05-1609-03
05-1609-04

16 cm/6 1/4"



Universal
05-1610-01
05-1610-02
05-1610-03
05-1610-04

18 cm/7"



Smith
05-1611-17
17.5 cm/7"



Harvey
05-1612-12
12.5 cm/5"

Saw edge



Schuknecht
05-1613-10
10 cm/4"

Saw edge



Nail Splinting Scissors

05-1614-13 13 cm/5"
05-1614-15 15 cm/6"



Lister
05-1615-09 09.0 cm/3 1/2"
05-1615-11 11.5 cm/4 1/2"
05-1615-14 14.0 cm/5 1/2"
05-1615-15 15.5 cm/6"
05-1615-18 18.0 cm/7"
05-1615-20 20.0 cm/8"



Lister
05-1616-18 18.5 cm/7 1/4"
05-1616-21 21.0 cm/8 1/4"



Lister-Excentric
05-1617-16 16 cm/6 1/4"
05-1617-19 19 cm/7 1/2"



Esmarch
05-1618-20 20 cm/8"
05-1618-22 22 cm/8 3/4"



Bergmann
05-1619-23
23 cm/9"



Lorenz
05-1620-23
23 cm/9"



Saw edge

05-1621-17
17 cm/6¾"



Lange
05-1622-18
18 cm/7"



Bruns
05-1623-24 24 cm/9½" Saw edge
05-1624-24 24 cm/9½" Smooth
05-1625-24 24 cm/9½" TC



Smith (Mod. USA)
05-1626-18 18 cm/7"
05-1626-20 20 cm/8"
05-1626-23 23 cm/9"



Knowles
05-1627-14
14 cm/5½"



Knowles
05-1628-14
14 cm/5½"



05-1629-13
13 cm/5"



05-1630-20
20 cm/8"



Seutin
05-1631-23
23 cm/9"



05-1632-23
23 cm/9"



Collin
05-1633-22
22 cm/8¾"



Gluck
05-1634-22
22 cm/8¾"



Stille
05-1635-21
21 cm/8¼"



Stille
05-1636-24
24 cm/9½"



Stille
05-1637-23 23 cm/9"
05-1637-26 26 cm/10¼"
05-1637-37 37 cm/14½"

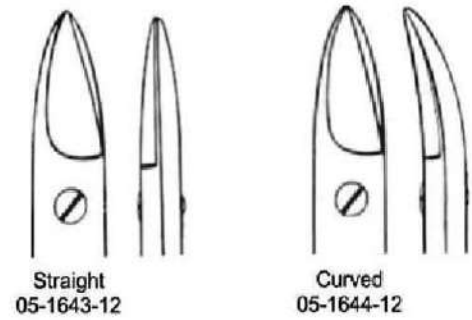
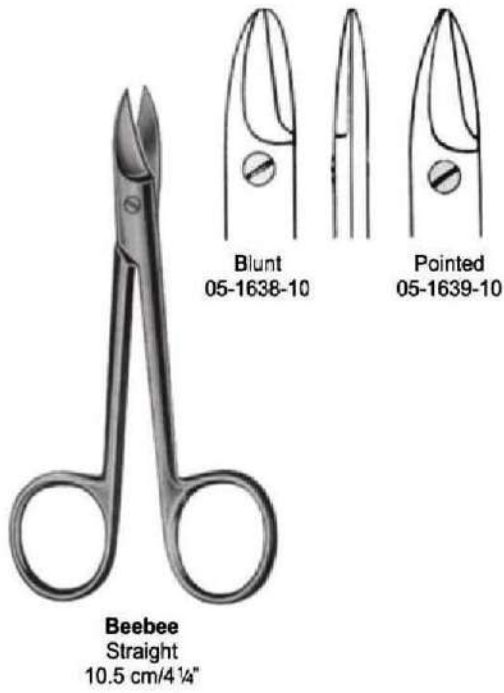



Saw edge

Goldmann-Fox
05-1645-13
13 cm/5"



Goldmann-Fox
05-1646-13
13 cm/5"



Niro
05-1647-14
14 cm/5½"



Saw edge

**Goldmann-Fox
(Spezial)**
05-1648-13
13 cm/5"



Fine

05-1649-11
11.5 cm/4½"



Quinby
05-1650-12
12 cm/4¾"



Quinby
05-1651-12
12 cm/4¾"



Dean
05-1652-17
17 cm/6¾"



Dean
05-1653-17
17 cm/6¾"



Locklin
05-1654-16
16.5 cm/6½"



Locklin
05-1655-16
16.5 cm/6½"



Sullivan
05-1656-14
14.5 cm/5¾"



Sullivan
05-1657-14
14.5 cm/5¾"



Neumann
05-1658-12
12.5 cm/5"



La Grange
05-1659-11
11.5 cm/4½"



05-1660-11	Standard 11.5 cm/4½"	05-1661-11	05-1662-11	Standard 11.5 cm/4½"	05-1663-11	05-1664-11	Chadwick 11.5 cm/4½"
------------	--------------------------------	------------	------------	--------------------------------	------------	------------	--------------------------------

Nail scissors



09.0 cm/3½"	05-1665-09	05-1666-09	05-1667-09	05-1668-09
10.5 cm/4¼"	05-1665-10	05-1666-10	05-1667-10	05-1668-10

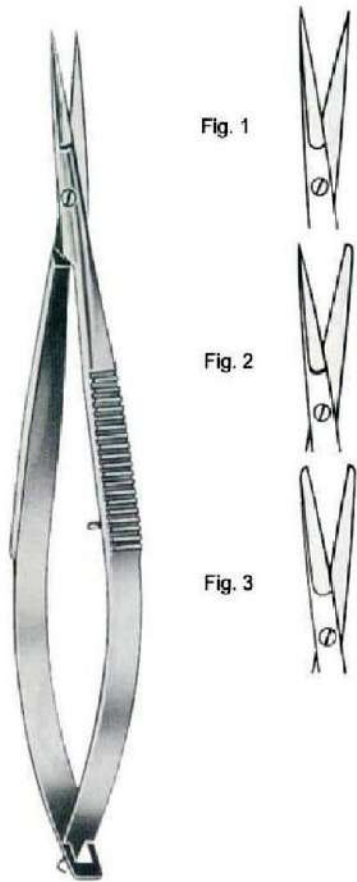

Fig. 1

Fig. 2

Fig. 3

Noyes
Fig.1 05-1669-01
Fig.2 05-1669-02
Fig.3 05-1669-03
12 cm/4 3/4"



Noyes
05-1670-12
12 cm/4 3/4"



05-1671-01

05-1671-02

Wecker
11.5 cm/4 1/2"



Barraquer
05-1672-05
5.5 cm/2 1/4"

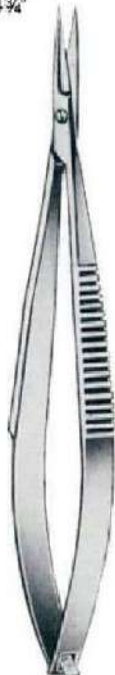

05-1673-09
9 cm/3 1/2"



05-1674-09



05-1675-09



05-1676-09



05-1677-09



05-1678-09



Straight

Vannas
05-1679-08
8 cm/3¼"



Curved

Vannas
05-1680-08
8 cm/3¼"

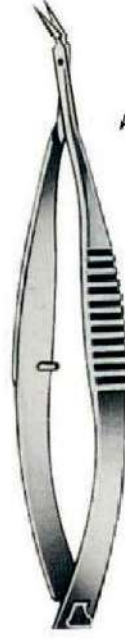

Angular

Vannas
05-1681-08
8 cm/3¼"



Vannas
05-1682-08
8 cm/3¼"



Straight

05-1683-08
8.5 cm/3¼"



Curved

05-1684-08
8.5 cm/3½"

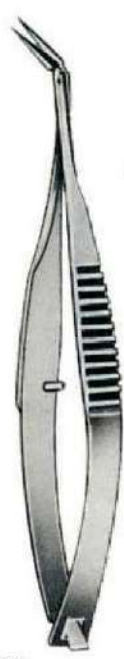

Angular

05-1685-08
8.5 cm/3½"



Angular

05-1686-08
8.5 cm/3½"

Vannas Mod, Tubingen



05-1687-10
10 cm/4"



05-1688-10
10 cm/4"



Castroviejo
05-1689-10
10 cm/4"



Castroviejo
05-1690-10
10 cm/4"



Aepli
05-1691-10
10 cm/4"



Castroviejo
05-1692-10
10 cm/4"



Castroviejo
05-1693-10
10 cm/4"



Troutman-Barraquer
05-1694-10
10 cm/4"



Troutman-Barraquer
05-1695-10
10 cm/4"



Troutman
05-1696-10
10 cm/4"



Troutman
05-1697-10
10 cm/4"



Katzin-Barraquer
05-1698-10
10 cm/4"



Katzin-Barraquer
05-1699-10
10 cm/4"



Katzin
05-1700-11
10 cm/4"



Katzin
05-1701-11
10 cm/4"



Westcott
05-1702-11
11 cm/4 1/2"



Westcott
05-1703-11
11 cm/4 1/2"



Westcott
05-1704-11
11 cm/4 1/2"



Castroviejo
05-1705-10
10 cm/4"

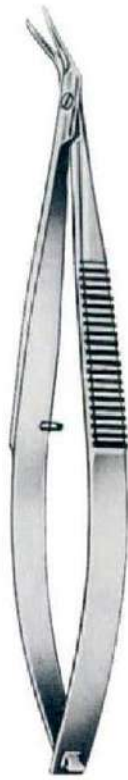

Castroviejo
05-1706-10
10 cm/4"



Castroviejo
05-1707-11
11.5 cm/4½"



Castroviejo
05-1708-11
11.5 cm/4½"



Troutmann-Castroviejo
05-1709-10
10.5 cm/4¼"



Troutmann-Castroviejo
05-1710-10
10.5 cm/4¼"



14.5 cm/5¾"
18.0 cm/7"

Straight
05-1711-14
05-1711-18

Curved
05-1712-14
05-1712-18



Straight

- 05-1713-12 12.0 cm/4 ³/₄"
- 05-1713-16 16.0 cm/6 ¹/₄"
- 05-1713-18 18.5 cm/7 ¹/₄"



Curved

- 05-1714-12 12.0 cm/4 ³/₄"
- 05-1714-16 16.0 cm/6 ¹/₄"
- 05-1714-18 18.5 cm/7 ¹/₄"

**Vannas
 Straight**

- 05-1715-12 12.0 cm/4 ³/₄"
- 05-1715-16 16.0 cm/6 ¹/₄"

**Vannas
 Curved**

- 05-1716-12 12.0 cm/4 ³/₄"
- 05-1716-16 16.0 cm/6 ¹/₄"



Yasargil

16.5cm/6½"
20.0cm/8"

20.0cm/8"

20.0cm/8"



Straight
05-1717-16
05-1717-20



Curved
05-1718-16
05-1718-20



Curved Downwards
05-1719-20

Dissecting Scissors



Straight
05-1720-20



Curved
05-1721-20



Yasargil

22.5cm/9"
24.5cm/9¾"



Straight
05-1722-22
05-1722-24



Curved
05-1723-22
05-1723-24



Curved Downwards
05-1724-22

22.5cm/9"

Dissecting Scissors



Straight
05-1725-22



Curved
05-1726-22

22.5cm/9"



Vein Scissors



Straight
05-1735-12
12cm/4 $\frac{3}{4}$ "



Curved
05-1736-12
12cm/4 $\frac{3}{4}$ "



Straight
05-1737-12
12cm/4 $\frac{3}{4}$ "



Curved
05-1738-12
12cm/4 $\frac{3}{4}$ "



Angled up
05-1739-12
12cm/4 $\frac{3}{4}$ "



Straight
105-1740-13
13cm/5 $\frac{1}{8}$ "



Saw Edge



Straight
105-1741-16
16cm/6¼"



Curved
105-1742-16
16cm/6¼"



Straight
105-1743-16
16cm/6¼"



Curved
105-1744-16
16cm/6¼"



Millesi
Straight
105-1745-16
16cm/6¼"



Millesi
Curved
105-1746-16
16cm/6¼"



Straight
105-1747-18
18.5cm/7¼"

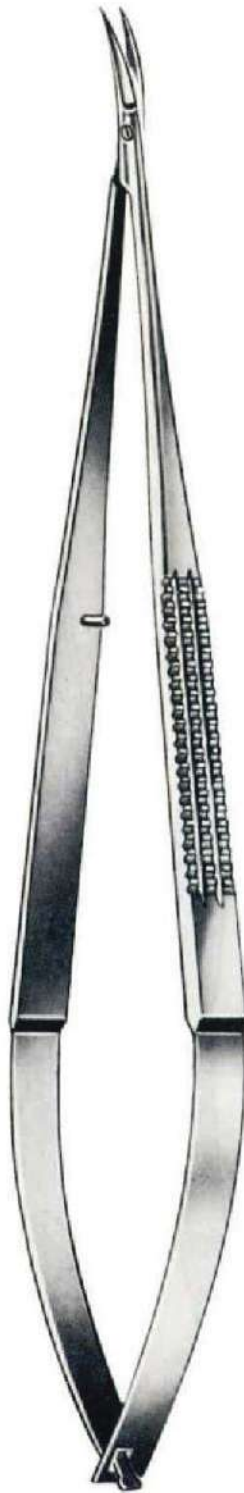

Curved
105-1748-18
18.5cm/7¼"

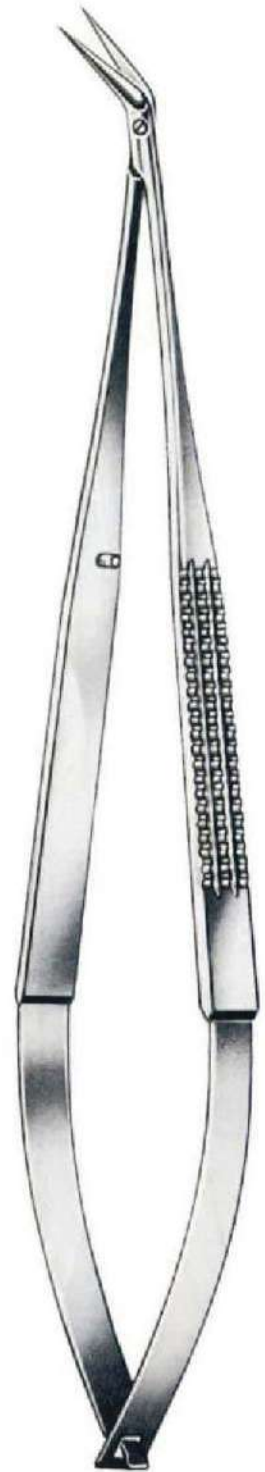

Angular
105-1749-18
18.5cm/7¼"



Saw Edge



Straight
105-1750-16
16cm/6 1/4"



Curved
105-1751-16
16cm/6 1/4"



Straight
105-1752-16
16cm/6 1/4"



Curved
105-1753-16
16cm/6 1/4"



Straight
105-1754-16
16cm/6 1/4"



Curved
105-1755-16
16cm/6 1/4"



Straight
105-1756-18
18.5cm/7 1/4"



Curved
105-1757-18
18.5cm/7 1/4"



Angular
105-1758-18
18.5cm/7 1/4"



Straight
105-1759-23
23cm/9"



Dissecting Scissors



Straight
105-1760-14
14.5cm/5¾"



Curved
105-1761-14
14.5cm/5¾"



Curved
105-1762-14
14.5cm/5¾"



Operating Scissor

Straight	Curved
05-1763-14	05-0682-14
14.5cm/5¾"	



Mayo

Straight	Curved
05-1764-14	05-1765-14
05-1764-17	05-1765-17
05-1764-23	05-1765-23
14.5cm/5¾"	17.0cm/6¾"
17.0cm/6¾"	23.0cm/9"



Mayo-Stille

Straight	Curved
05-1766-15	05-1767-15
05-1766-17	05-1767-17
15.0cm/6"	17.0cm/6¾"



Lexer

Straight	Curved
05-1768-16	05-1769-16
16cm/6¼"	



Baby-Metzenbaum

Straight	Curved
05-1770-11	05-1771-11
11.5cm/4½"	



Metzenbaum-Fine

Straight	Curved
05-1772-14	05-1773-14
14.5cm/5¾"	



Metzenbaum-Fine

Straight	Curved
05-1774-18	05-1775-18
05-1774-20	05-1775-20
05-1774-23	05-1775-23
18cm/7"	20cm/8"
20cm/8"	23cm/9"



Sims
Straight Curved
05-1776-20 20 cm/8" 05-1777-20
05-1776-23 23 cm/9" 05-1777-23



Siebold
05-1778-24
24 cm/9½"



Jameson
05-1779-15 15 cm/6"
05-1779-18 18 cm/7"



Reynolds
Straight Curved
05-1780-15 05-1781-15
15 cm/6"



Straight Curved
05-1782-11 05-1783-11
11.5 cm/4½"



Straight Curved
05-1784-11 05-1785-11
11.5 cm/4½"



Plastic Surgery
Straight Curved
05-1786-12 05-1787-12
12 cm/4¾"



Wagner
Straight Curved
05-1788-12 05-1789-12
12 cm/4¾"



05-1790-11
11.5 cm/4½"

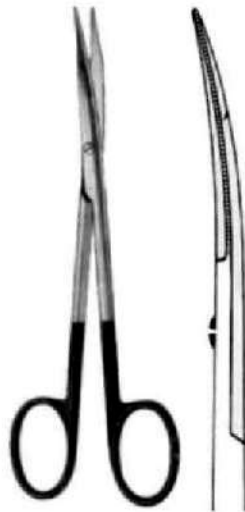

05-1791-14
14cm/5½"



Reynolds
05-1792-13
13cm/5"

**Endarterectomy
Scissors**



Potts-Smith
19cm/7½"

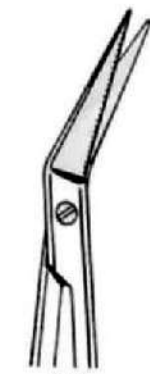

25°
05-1793-19

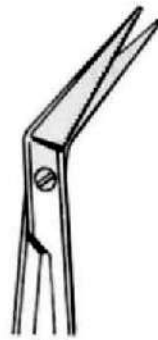

45°
05-1794-19



60°
05-1795-19



05-1796-17
17cm/6¾"



Lister
05-1797-14 14.5cm/5¾"
05-1797-18 18cm/7"
05-1797-20 20cm/8"



Braun-Stadler
05-1798-14 14.5cm/5¾"
05-1798-22 22cm/8¾"



Stevens
Straight 05-1799-11 11.5cm/4½"
Curved 05-1800-11



Heymann
05-1801-18
18cm/7"



Fomon
05-1802-13
13cm/5"



Fomon
05-1803-13
13cm/5"



Cottle
05-1804-16
16cm/6¼"



Standard
14.5cm/5¾"



Fig. 1
05-1805-14



Fig. 2
05-1806-14

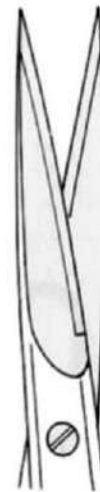
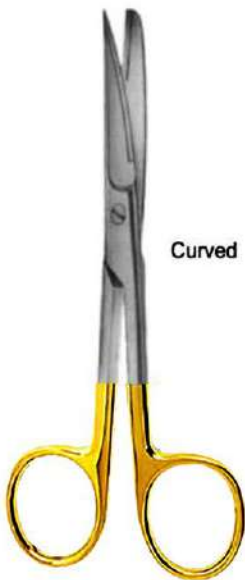

Fig. 3
05-1807-14



Curved

Standard
14.5cm/5¾"



Fig. 1
05-1808-14



Fig. 2
05-1809-14



Fig. 3
05-1810-14



Lexer
Straight
05-1811-16
16 cm/6¼"



Lexer
Curved
05-1812-16
16 cm/6¼"



Mayo
Straight
05-1813-14 14.5 cm/5¾"
05-1813-18 18.0 cm/7"
05-1813-23 23.0 cm/9"



Mayo
Curved
05-1814-14 14.5 cm/5¾"
05-1814-18 18.0 cm/7"
05-1814-23 23.0 cm/9"



Lexer-Fine
Straight
005-1815-16
16 cm/6¼"



Lexer-Fine
Curved
05-1816-16
16 cm/6¼"



Mayo-Stille
Straight
05-1817-15 15 cm/6"
05-1817-17 17 cm/6¾"



Mayo-Stille
Curved
05-1818-15 15 cm/6"
05-1818-17 17 cm/6¾"



Metzenbaum
05-1819-14
14.5 cm/5¾"



Metzenbaum-Fine
05-1820-14
14.5 cm/5¾"

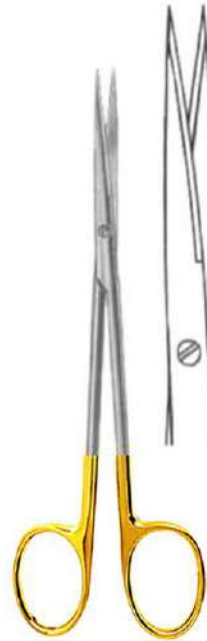

Metzenbaum-Fine
05-1821-14
14.5 cm/5¾"

Curved



Metzenbaum
05-1822-14
14.5 cm/5¾"



Metzenbaum-Fine
05-1823-14
14.5 cm/5¾"

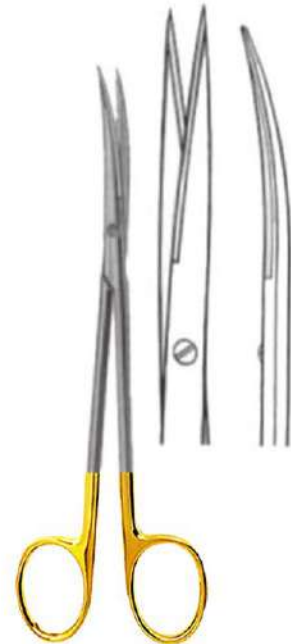

Metzenbaum-Fine
05-1824-14
14.5 cm/5¾"



Straight



	Metzenbaum
18 cm/7"	05-1825-18
20 cm/8"	05-1825-20
23 cm/9"	05-1825-23
25 cm/10"	05-1825-25
28 cm/11"	05-1825-28
30 cm/12"	05-1825-30



	Metzenbaum-Fine
	05-1826-18
	05-1826-20
	05-1826-23
	05-1826-25
	05-1826-28
	05-1826-30



	Metzenbaum-Fine
	05-1827-18
	05-1827-20
	05-1827-23
	05-1827-25
	05-1827-28
	05-1827-30

Curved



	Metzenbaum
18 cm/7"	05-1828-18
20 cm/8"	05-1828-20
23 cm/9"	05-1828-23
25 cm/10"	05-1828-25
28 cm/11"	05-1828-28
30 cm/12"	05-1828-30



	Metzenbaum-Fine
	05-1829-18
	05-1829-20
	05-1829-23
	05-1829-25
	05-1829-28
	05-1829-30



	Metzenbaum-Fine
	05-1830-18
	05-1830-20
	05-1830-23
	05-1830-25
	05-1830-28
	05-1830-30

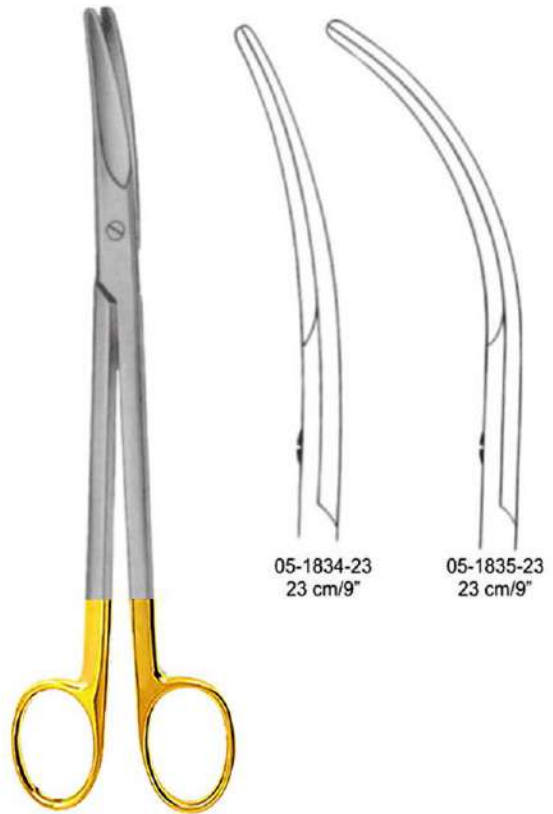
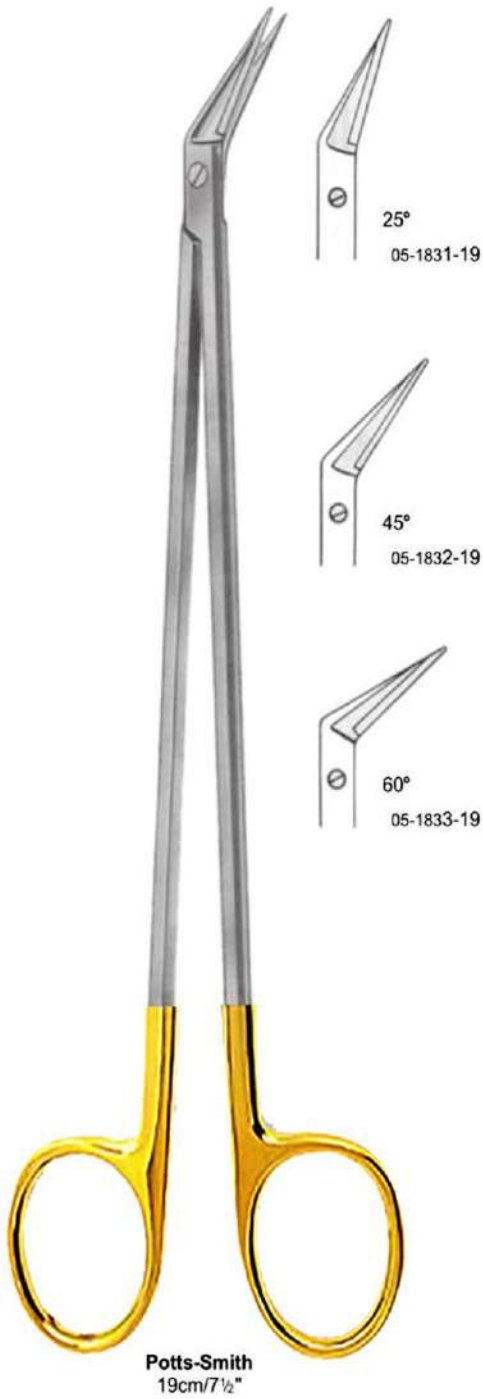



Lister
05-1838-18
18 cm/7"



Universal
05-1839-12
12 cm/4 3/4"



Goldman-Fox
Straight
05-1840-13
13 cm/5"



Goldman-Fox
Curved
05-1841-13
13 cm/5"



Straight
05-1842-11



11.5cm/4 1/2"

Curved
05-1843-11



Straight
05-1844-11

11.5cm/4 1/2"



Curved
05-1845-11



Fig. 1



Fig. 2



Fig. 3

Noyes
Fig.1 16-4739-01
Fig.2 16-4739-02
Fig.3 16-4739-03
12 cm/4 3/4"



Noyes
16-4740-12
12 cm/4 3/4"



16-4741-01



16-4742-02

Wecker
11.5 cm/4 1/2"



Barraquer
16-4743-05
5.5 cm/2 1/4"



16-4744-09
9 cm/3 1/2"



16-4745-09



16-4746-09



16-4747-09



16-4748-09



16-4749-09

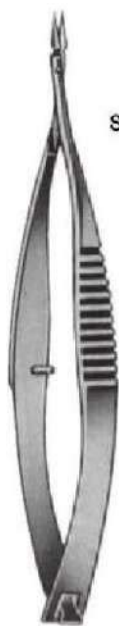

Straight

Vannas
16-4750-08
8 cm/3 1/4"

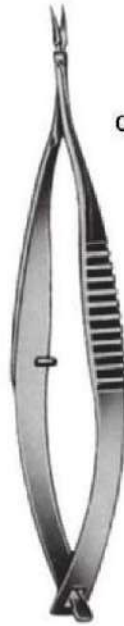

Curved

Vannas
16-4751-08
8 cm/3 1/4"



Angular

Vannas
16-4752-08
8 cm/3 1/4"

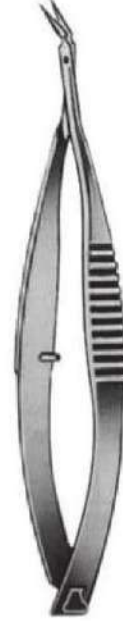

Vannas
16-4753-08
8 cm/3 1/4"



Straight

16-4754-08
8.5 cm/3 1/4"



Curved

16-4755-08
8.5 cm/3 1/4"



Angular

16-4756-08
8.5 cm/3 1/4"



Angular

16-4757-08
8.5 cm/3 1/4"

Vannas Mod, Tubingen



16-4758-10
10 cm/4"



16-4759-10
10 cm/4"



Castroviejo
16-4760-10
10 cm/4"



Castroviejo
16-4761-10
10 cm/4"



Aebli
16-4762-10
10 cm/4"

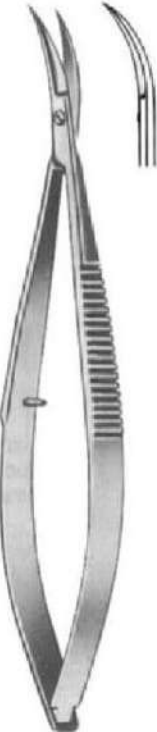

Castroviejo
16-4763-10
10 cm/4"



Castroviejo
16-4764-10
10 cm/4"



Troutman-Barraquer
16-4765-10
10 cm/4"



Troutman-Barraquer
16-4766-10
10 cm/4"



Saw Edge

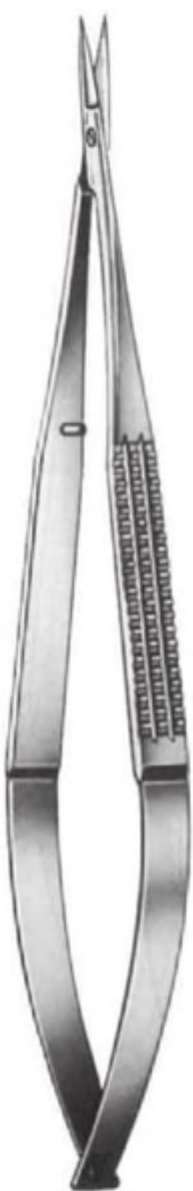

Straight
16-4767-16
16cm/6 1/4"

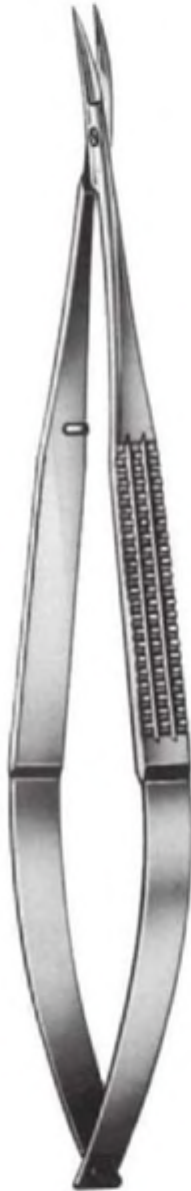

Curved
16-4768-16
16cm/6 1/4"



Straight
16-4769-16
16cm/6 1/4"



Curved
16-4770-16
16cm/6 1/4"



Millesi
Straight
16-4771-16
16cm/6 1/4"



Millesi
Curved
16-4772-16
16cm/6 1/4"



Straight
16-4773-18
18.5cm/7 1/4"



Curved
16-4774-18
18.5cm/7 1/4"



Angular
16-4775-18
18.5cm/7 1/4"



Straight
16-4776-23
23cm/9"



Dissecting Scissors



Straight
16-4777-14
14.5cm/5 3/4"



Curved
16-4778-14
14.5cm/5 3/4"



Curved
16-4779-14
14.5cm/5 3/4"



Metzenbaum Scissor Cvd.
 20-5404-18
 18cm/7"



29-6706-10
 29-6706-10
 10 cm/4"

Straight
 Curved



29-6707-10
 29-6707-10
 10 cm/4"

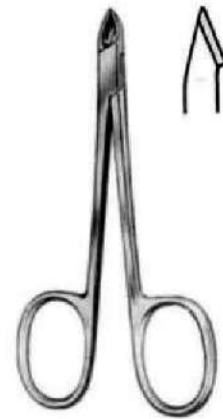

29-6708-10
 10 cm/4"



Forceps Family



Terrier
07-2101-10 10 cm/4"



Pennington
07-2102-15 15 cm/6"
07-2102-20 20 cm/8"



Pean
07-2103-12 12.5 cm/5"



Pean
07-2104-14 14 cm/5 3/4"
07-2104-16 16 cm/6 1/4"



Pean
07-2105-14 14 cm/5 1/2"



Collin
07-2106-15 15.5 cm/6"



Collin
07-2107-14 14 cm/5 1/2"



Collin
07-2108-16 16.5 cm/6 1/2"



Hartmann
10 cm/4"



07-2109-10



07-2110-10



07-2113-12
07-2113-14



07-2114-12
07-2114-14



07-2111-10



07-2112-10



07-2115-12
07-2111-14



07-2116-12
07-2116-14



Halstead-Mosquito
12 cm/4¾"
14 cm/5½"



Micro-Mosquito
10 cm/4"
12 cm/4¾"



07-2117-10
07-2117-12



07-2118-10
07-2118-12



07-2119-10
07-2119-12



07-2120-10
07-2120-12

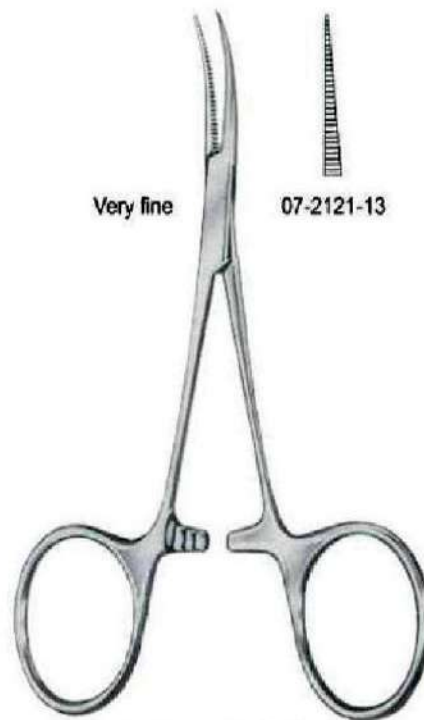

Very fine



07-2121-13



07-2122-13

Jacobson-Halstead
13 cm/5"

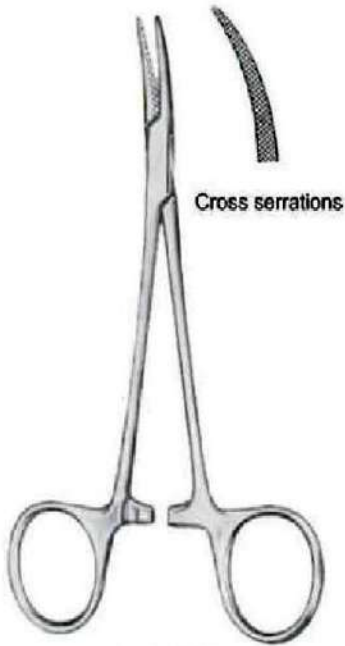

Cross serrations

07-2123-12
 12 cm/4¾"



Halstead-Mosquito
 18 cm/7"
 21 cm/8¼"



07-2124-18
 07-2124-21



07-2125-18
 07-2125-21



07-2126-18
 07-2126-21



07-2127-18
 07-2127-21



Kelly
 14 cm/5½"

Kelly-Rankin
 16 cm/6¼"



07-2128-14



14 cm/5½" 07-2129-14



07-2130-16



16 cm/6¼" 07-2131-16



Crile
14 cm/5½"

Crile-Rankin
16 cm/6¼"

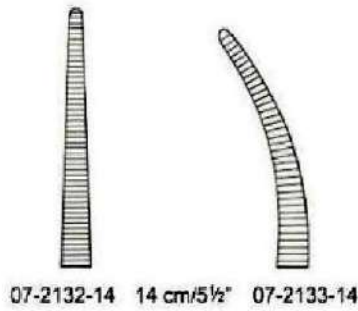

07-2132-14 14 cm/5½" 07-2133-14

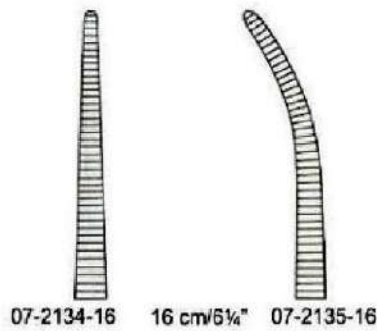

07-2134-16 16 cm/6¼" 07-2135-16



Baby-Crile
14 cm/5½"

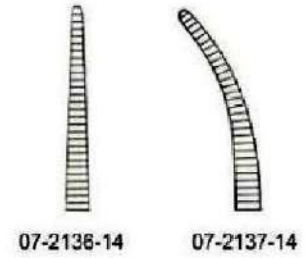

07-2136-14 07-2137-14



Crile
14 cm/5½"

Crile-Rankin
16 cm/6¼"

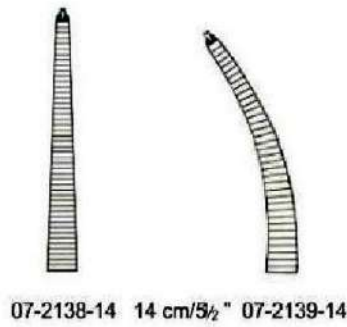

07-2138-14 14 cm/5½" 07-2139-14

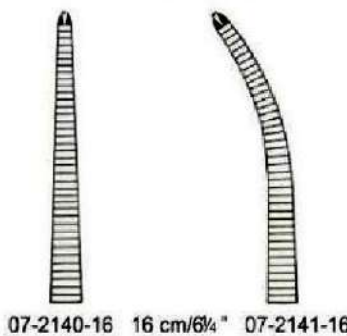

07-2140-16 16 cm/6¼" 07-2141-16



Baby-Crile
14 cm/5½"

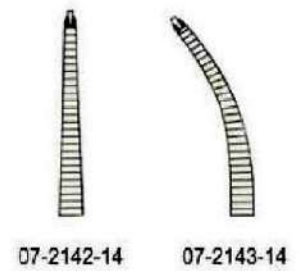

07-2142-14 07-2143-14



Collier-Crile



07-2144-14 14 cm/5½"



07-2146-16 16 cm/6¼"



Collier-Crile
07-2147-16
16 cm/6¼"



Leriche
15 cm/6"



07-2148-15



07-2149-15



07-2150-15



07-2151-15



Providence
14 cm/5½"



07-2152-14



07-2153-14

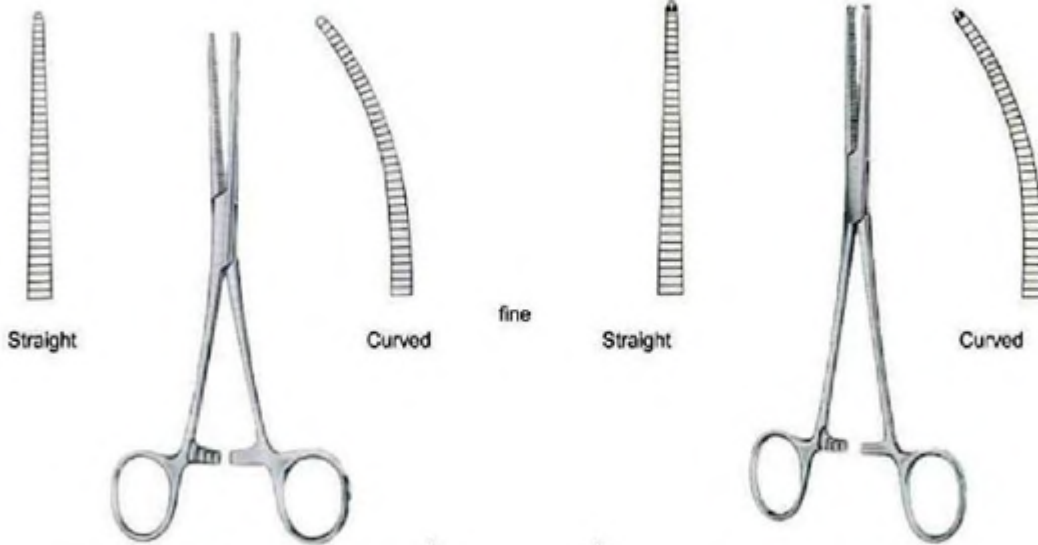

Rochester-Pean		cm	in	Ochsner-Kocher	
07-2154-13	07-2155-13	13.0	5"	07-2156-13	07-2157-13
07-2154-14	07-2155-14	14.0	5½"	07-2156-14	07-2157-14
07-2154-16	07-2155-16	16.0	6¼"	07-2156-16	07-2157-16

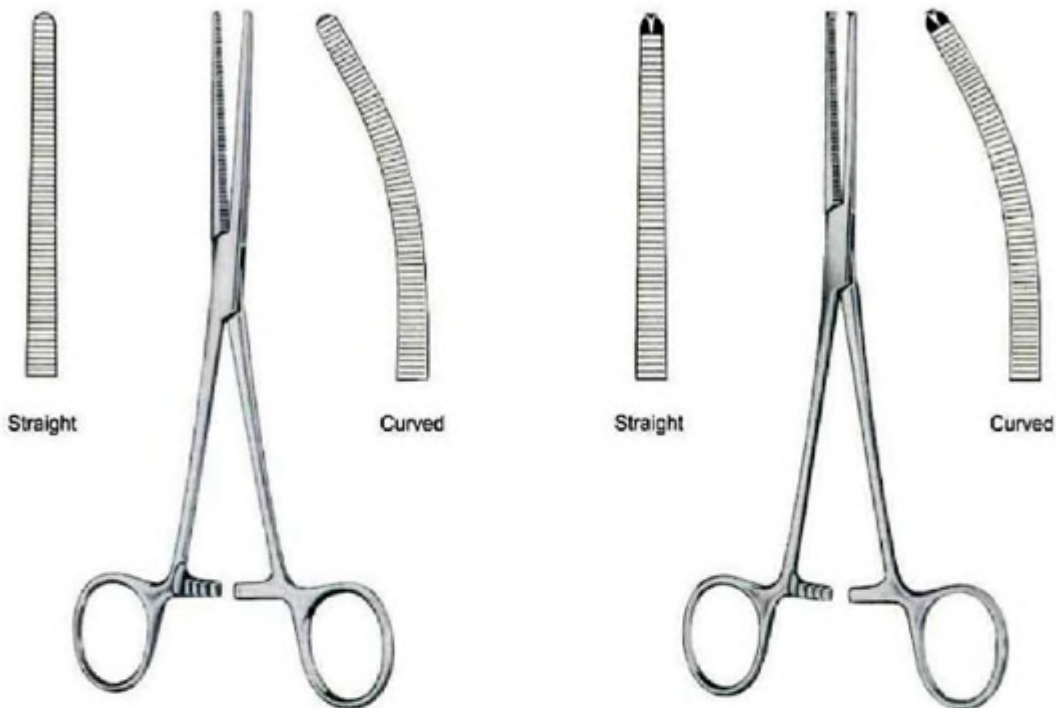

Rochester-Pean		cm	in	Ochsner-Kocher	
07-2158-13	07-2159-13	13.0	5"	07-2160-13	07-2161-13
07-2158-14	07-2159-14	14.0	5½"	07-2160-14	07-2161-14
07-2158-16	07-2159-16	16.0	6¼"	07-2160-16	07-2161-16
07-2158-18	07-2159-18	18.0	7"	07-2160-18	07-2161-18
07-2158-20	07-2159-20	20.0	8"	07-2160-20	07-2161-20
07-2158-22	07-2159-22	22.0	8¾"	07-2160-22	07-2161-22
07-2158-24	07-2159-24	24.0	9½"	07-2160-24	07-2161-24
07-2158-26	07-2159-26	26.0	10¼"	07-2160-26	07-2161-26
07-2158-30	07-2159-30	30.0	12"	07-2160-30	07-2161-30

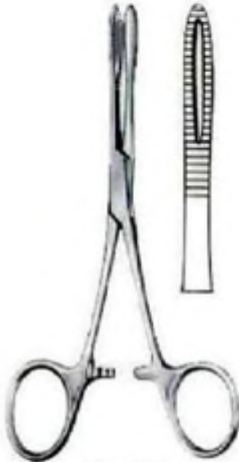

Kronlein
07-2162-13
13cm/5"



Brand
07-2163-15 15cm/6"
07-2163-19 19cm/7 1/2"
07-2163-24 24cm/9 1/2"



Brand
07-2164-15 15cm/6"
07-2164-19 19cm/7 1/2"
07-2164-24 24cm/9 1/2"



07-2165-16
07-2165-20

07-2166-16
07-2166-20



Rochester-Carmalt
16cm/6 1/4"
20cm/8"

Lateral Curved



07-2167-12



Mosquito-Dandy
12cm/4 1/4"



07-2169-14

07-2168-12



Dandy
14cm/5 1/2"

07-2170-14



Lovelace
07-2171-15
15.5cm/6"



Dixon-Lovelace
07-2172-16
16cm/6¼"



Dixon-Lovelace
07-2173-16
16cm/6¼"



Bainbridge
15cm/6"
18cm/7"



07-2174-15
07-2174-18



07-2175-15
07-2175-18



Fuchsig
07-2176-19
19cm/7½"





Adson
18.5cm/7¹/₄"



07-2177-18



07-2178-18



07-2179-18



07-2180-18



Nissen
07-2181-18 18.5cm/7 ¹/₄"
07-2181-22 22.0cm/8 ³/₄"



Baby-Adson



07-2182-14
14cm/5¹/₂"



07-2182-18
18cm/7"

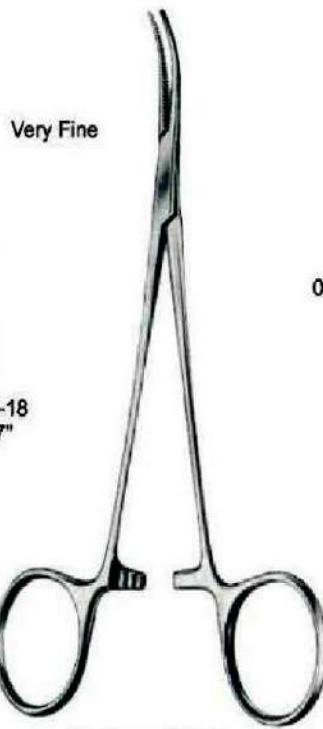

Jacobson-Adson
18cm/7"

Very Fine



07-2183-18



07-2184-18



07-2185-18

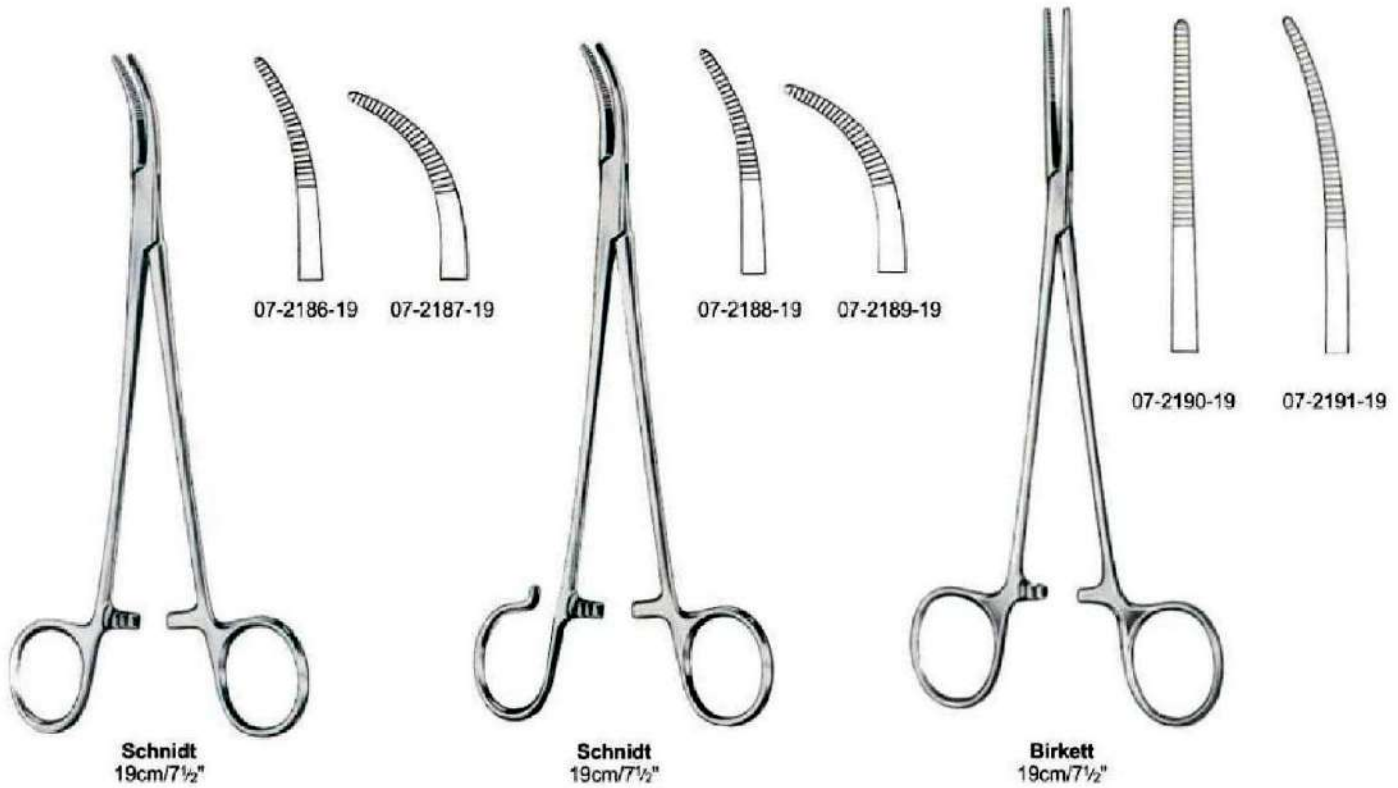

Schnidt
19cm/7 1/2"

Schnidt
19cm/7 1/2"

Birkett
19cm/7 1/2"



Bengolea

20cm/8"	07-2192-20	07-2193-20	07-2194-20	07-2195-20
22cm/8 3/4"	07-2192-22	07-2193-22	07-2194-22	07-2195-22
24cm/9 1/2"	07-2192-24	07-2193-24	07-2194-24	07-2195-24
26cm/10 1/4"	07-2192-26	07-2193-26	07-2194-26	07-2195-26



Bridge
27cm/10½"

07-2196-27



07-2197-27



Roberts
22cm/8¾"

07-2198-22



07-2199-22



Kelly

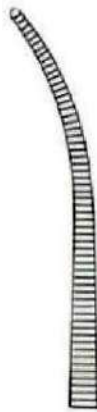

19cm/7½"
22cm/8¾"
24cm/9½"

07-2200-19
07-2200-22
07-2200-24



07-2201-19
07-2201-22
07-2201-24



07-2202-19
07-2202-22
07-2202-24

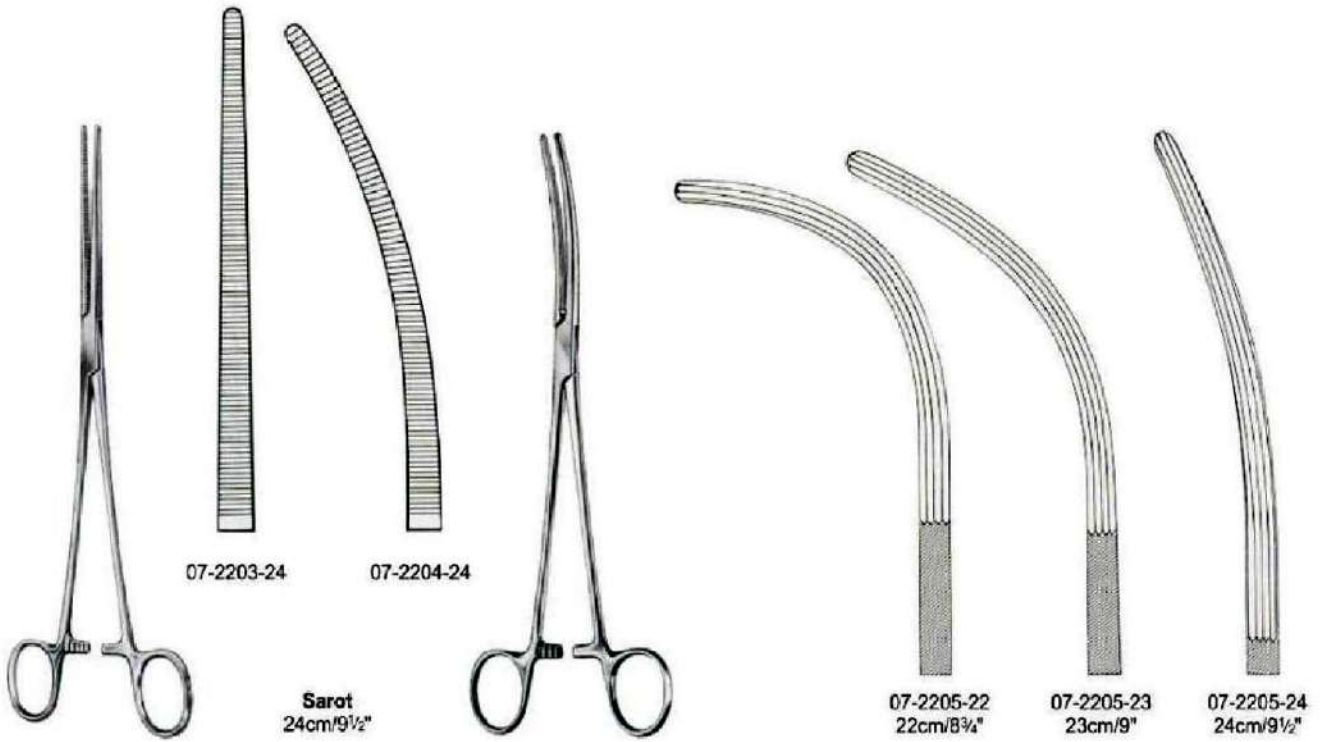

Crafoord-Sellors





Rumel
23cm/9"



07-2208-23



07-2209-23



07-2210-23

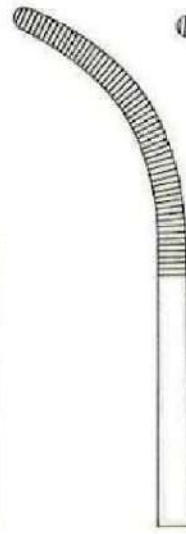

07-2211-23

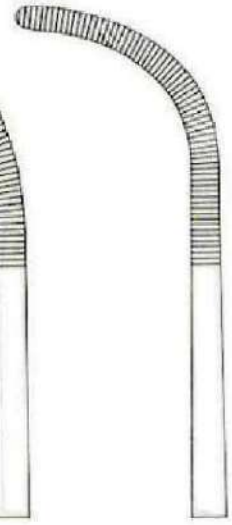

07-2212-23



Johns Hopkins
07-2213-20
20cm/8"



Zenker
29.5cm/11½"



07-2214-29



07-2215-29



07-2216-29

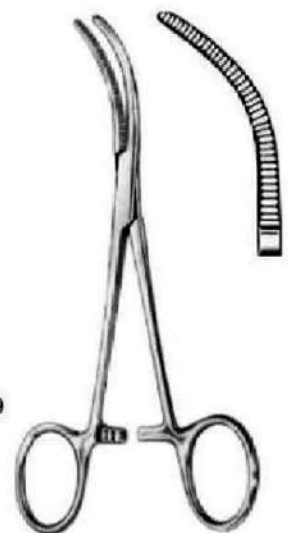

Baby-Overholt
07-2217-13
13.5cm/5¼"



Overholt-Slim



07-2218-18
16.5cm/7 1/4"



07-2219-20
20.5cm/8"



07-2220-21
21cm/8 1/4"

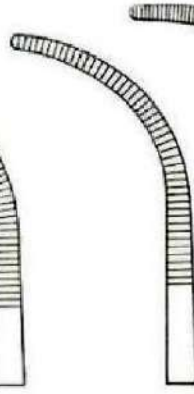

07-2221-21
21.5cm/8 1/2"

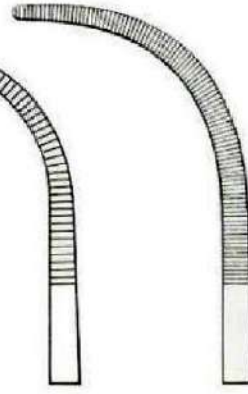

07-2222-24
24cm/9 1/2"

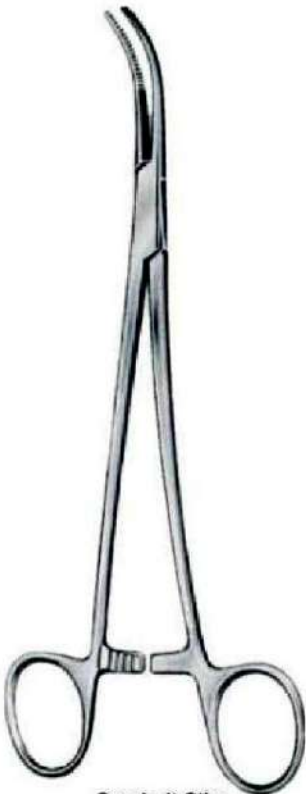

Overholt-Slim



07-2223-18
18.5cm/7 1/4"



07-2224-20
20.5cm/8"



07-2225-21
21cm/8 1/4"

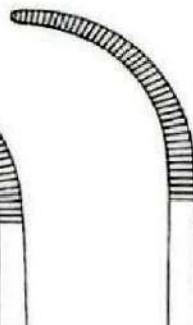

07-2226-21
21.5cm/8 1/4"





Overholt-Geissendorfer
21cm/8¼"
27cm/10½"

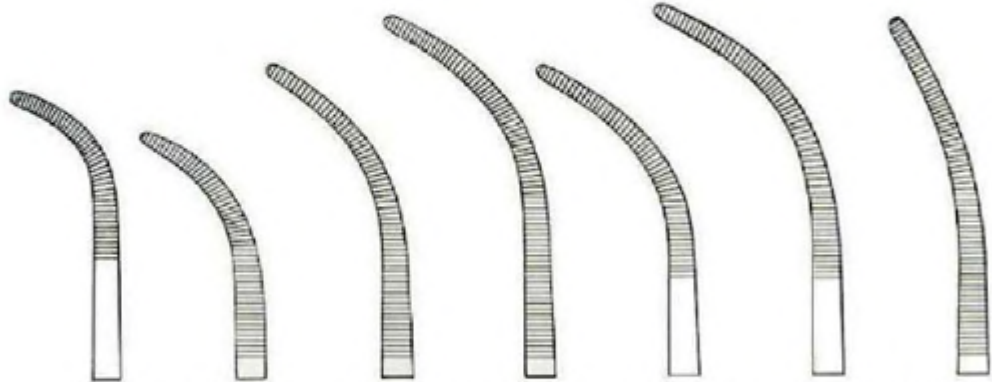

- 07-2227-21
07-2227-27
- 07-2228-21
07-2228-27
- 07-2229-21
07-2229-27
- 07-2230-21
07-2233-27
- 07-2231-21
07-2231-27
- 07-2232-21
07-2232-27
- 07-2233-21
07-2233-27



Overholt-Mixter
07-2234-21
21cm/8¼"



Heiss
20cm/8"

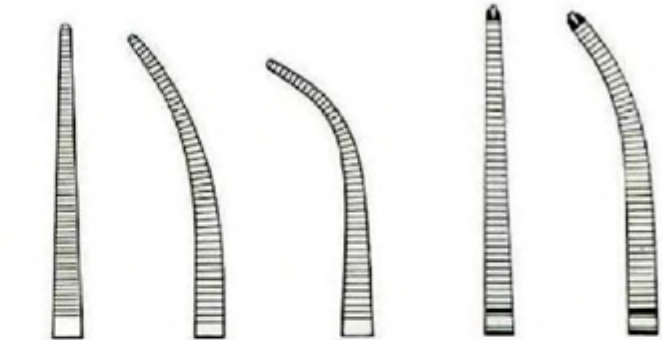

- 07-2235-20
- 07-2236-20
- 07-2237-20
- 07-2238-20
- 07-2239-20



Meeker
07-2240-27
27 cm/10½"



Toennis
21 cm/8¼"
26 cm/10¼"

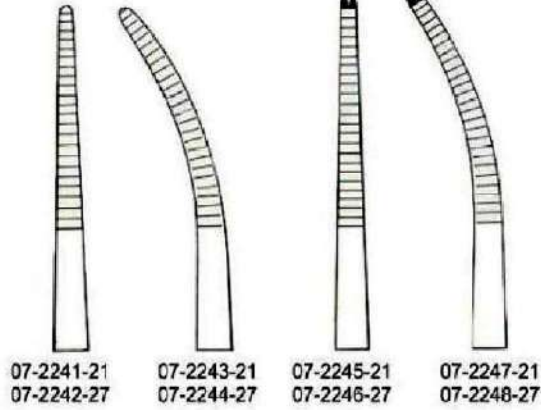

07-2241-21
07-2242-27
07-2243-21
07-2244-27
07-2245-21
07-2246-27
07-2247-21
07-2248-27



Lower
07-2249-18
18 cm/7"



Gemini

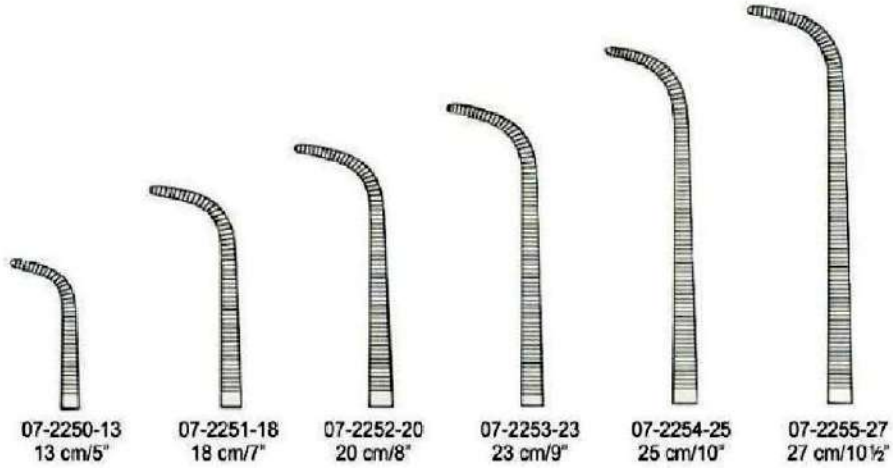

07-2250-13
13 cm/5"
07-2251-18
18 cm/7"
07-2252-20
20 cm/8"
07-2253-23
23 cm/9"
07-2254-25
25 cm/10"
07-2255-27
27 cm/10½"



Mini-Gemini

07-2256-18
18 cm/7"



07-2256-22
22 cm/8 3/4"



07-2256-25
25 cm/10"



07-2256-28
28 cm/11"

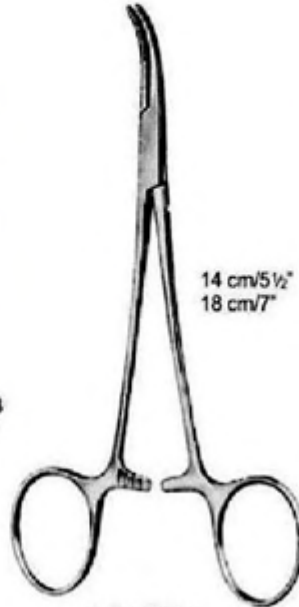

Baby-Mixer

14 cm/5 1/2"
18 cm/7"



07-2257-14
07-2257-18



07-2258-14
07-2258-18



Mixer
07-2259-15 15 cm/6"
07-2259-19 19 cm/7 1/2"



Mixer-O'Shaugnessy
07-2260-15 15.5 cm/6"
07-2260-19 19.0 cm/7 1/2"



Mixer-Slim

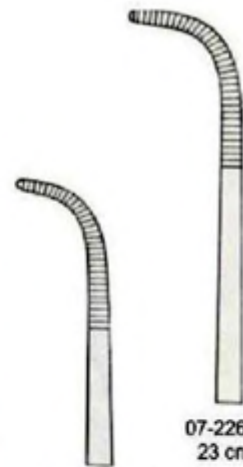

07-2261-18
18 cm/7"

07-2261-23
23 cm/9"



07-2262-22
22 cm/8 3/4"

Mixer



07-2262-25
25 cm/10"

07-2262-28
28 cm/11"



Mixer
07-2263-22
22 cm/8 3/4"



Wickstroem
07-2264-20
20 cm/8"



Finocchietto
07-2265-24
24 cm/9 1/2"

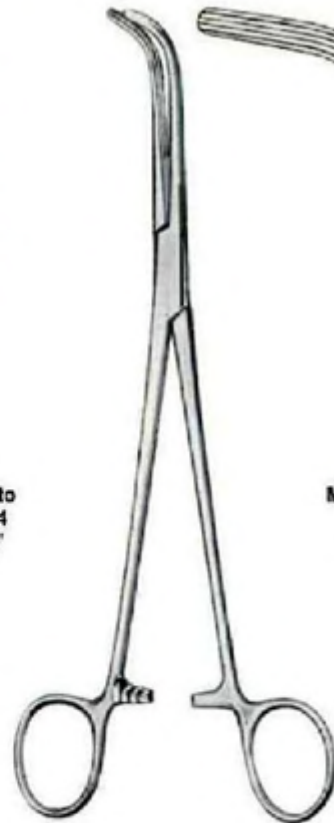

Mc Quigg-Mixer
07-2266-22
22 cm/8 3/4"





Lawrence
07-2267-27
27.5 cm/10¾"



07-2268-19
19 cm/7½"



07-2269-23
23 cm/9"



Spencer-Wells

- | | | |
|------------|----------|------------|
| 07-2270-13 | 13 cm/5" | 07-2271-13 |
| 07-2270-15 | 15 cm/6" | 07-2271-15 |
| 07-2270-18 | 18 cm/7" | 07-2271-18 |
| 07-2270-20 | 20 cm/8" | 07-2271-20 |
| 07-2270-23 | 23 cm/9" | 07-2271-23 |



Spencer-Wells

- | | | |
|------------|-----------|------------|
| 07-2272-13 | 13 cm/5" | 07-2273-13 |
| 07-2272-14 | 14 cm/5½" | 07-2273-14 |
| 07-2272-15 | 15 cm/6" | 07-2273-15 |
| 07-2272-18 | 18 cm/7" | 07-2273-18 |
| 07-2272-20 | 20 cm/8" | 07-2273-20 |
| 07-2272-23 | 23 cm/9" | 07-2273-23 |



Rogers



07-2274-22
22.5 cm/9"
07-2274-25
25.0 cm/10"



07-2275-22
22.0 cm/8³/₄"
07-2275-24
24.5 cm/9³/₄"



07-2276-21
21.5 cm/8¹/₂"
07-2276-24
24.0 cm/9¹/₂"

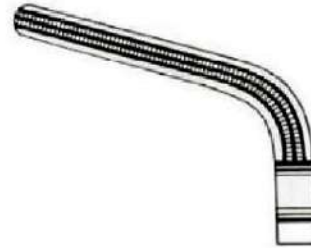

07-2277-20
20.5 cm/8"
07-2277-23
23.5 cm/9"



Heaney



19.5 cm/7¹/₂" 07-2278-19
21.5 cm/8¹/₄" 07-2278-21
23.5 cm/9" 07-2278-23



07-2279-19
07-2279-21
07-2279-23



Heaney-Slim
07-2280-21
21 cm/8¹/₄"





Ballentine
07-2281-21
21cm/8¼"



Heaney-Ballentine
07-2282-21
21cm/8¼"



Tonsil Forceps

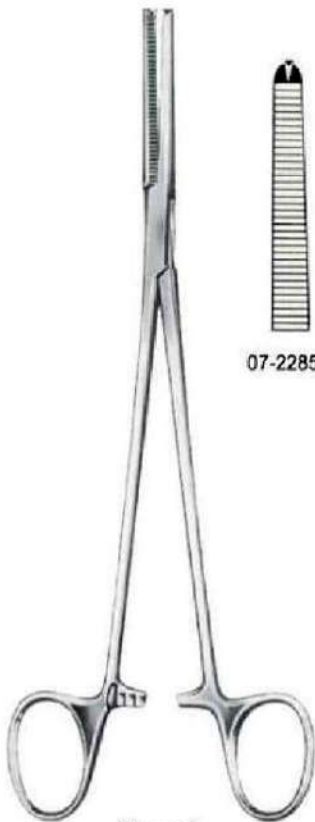

Fig. 1



Fig. 2

Negus
07-2283-19 19cm/7½" 07-2284-19



Phaneuf
21.5cm/8½"



07-2285-21



07-2286-21

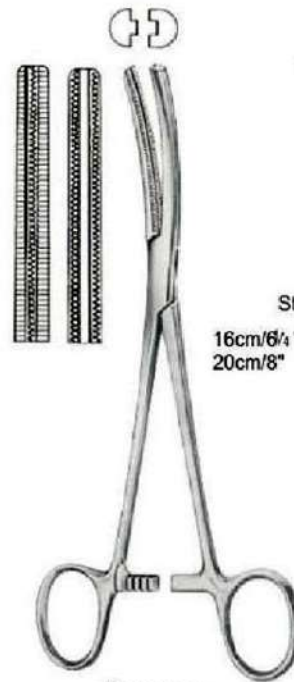

Fergusson

Haemorrhoidal Clamps



	Straight		Curved
16cm/6¼"	07-2287-16	07-2288-16	
20cm/8"	07-2287-20	07-2288-20	

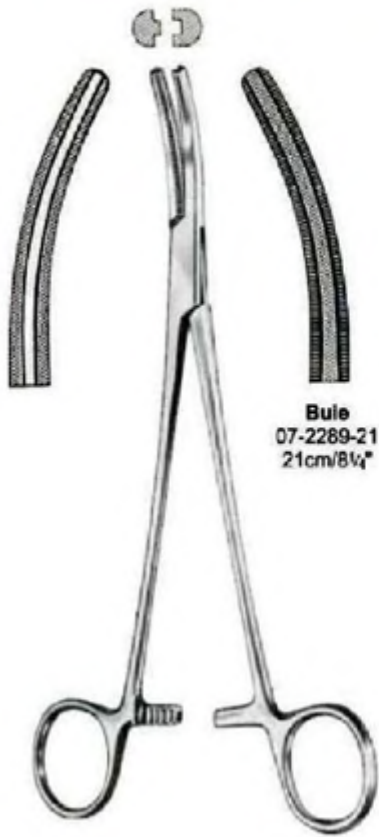

Bule
07-2289-21
21cm/8¼"

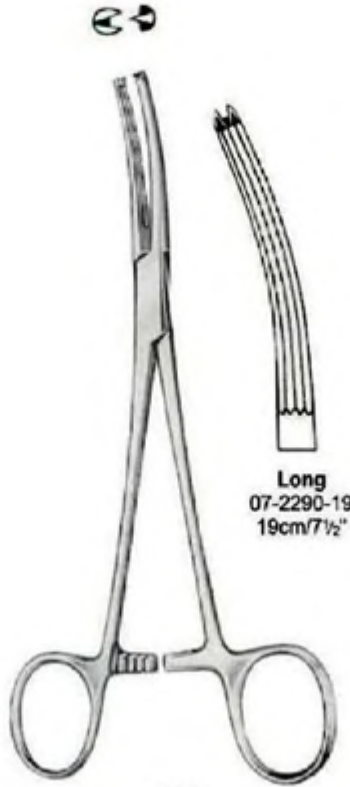

Long
07-2290-19
19cm/7½"



Garland
07-2291-21
21cm/8¼"

Gall Duct Clamps

Hysterectomy Forceps

Pressure Clamps



07-2292-23
23cm/9"

07-2292-24
24cm/9½"

Moynihan



07-2293-23

07-2294-23

Hozibach
23.5cm/9¼"



Zweifel
07-2295-17
17.5cm/7"

Scalp Flap Forceps

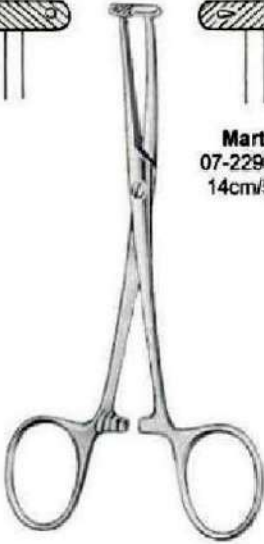

Martel
07-2296-14
14cm/5½"



Wertheim
07-2297-25
25cm/10"

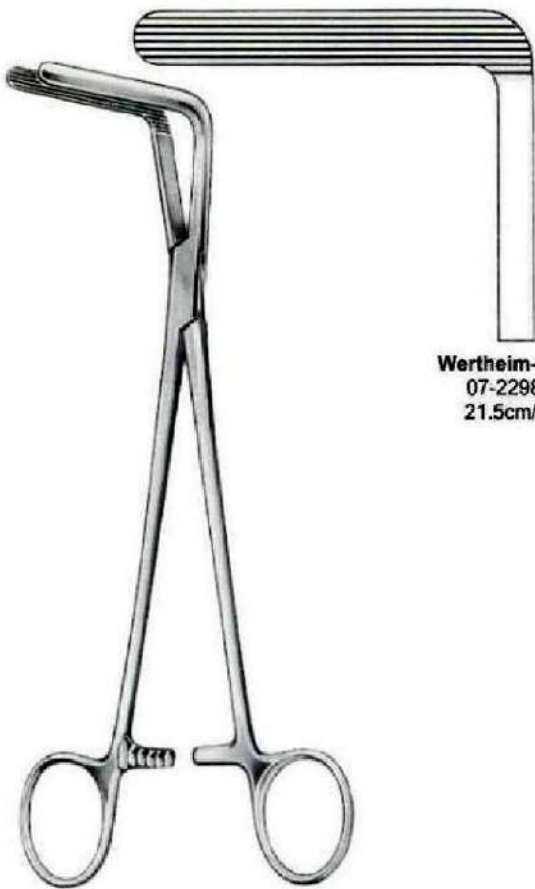

Wertheim-Cullen
07-2298-21
21.5cm/8½"

Extra Strong



Wertheim
07-2299-24
24cm/9½"

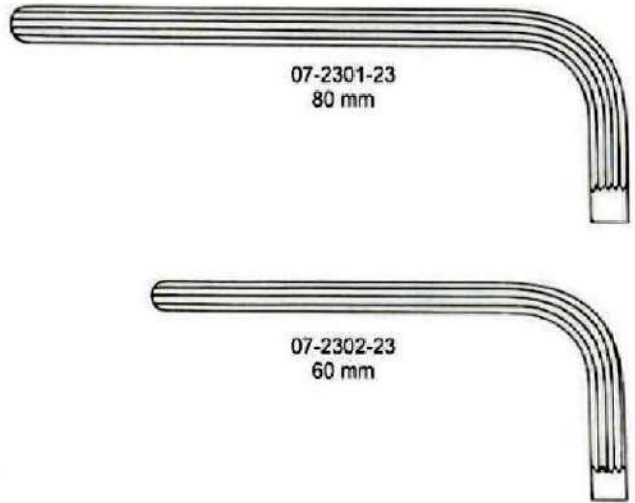
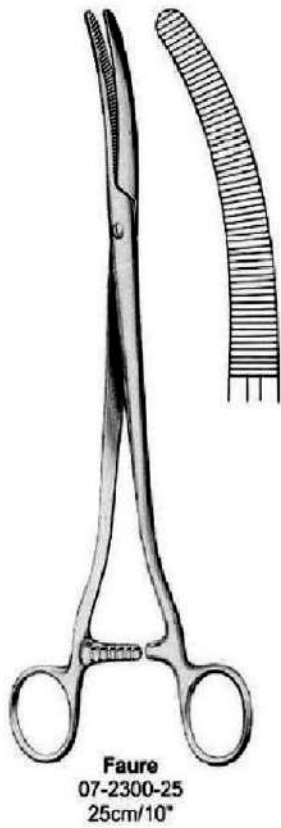

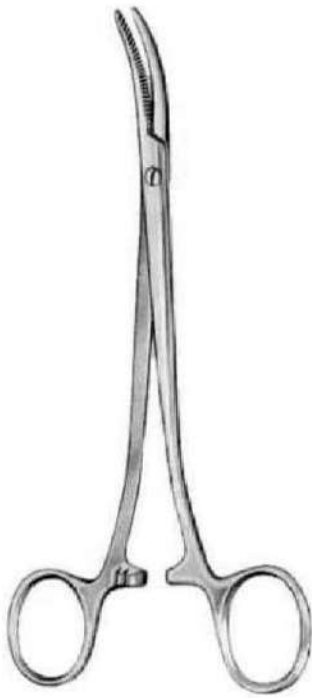

Wertheim
07-2306-18
18 cm/7"

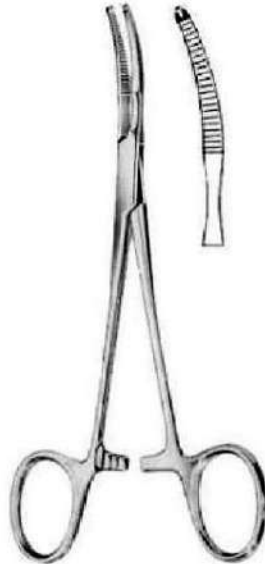

Baby-Mikulicz
07-2307-14
14 cm/5½"

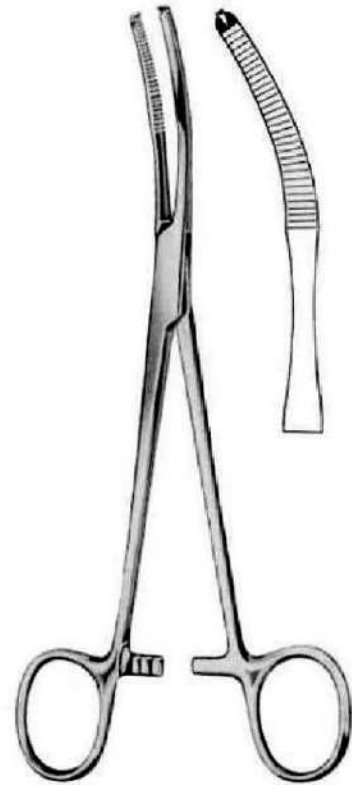

Mikulicz
07-2308-18 18cm/7"
07-2308-20 20cm/8"

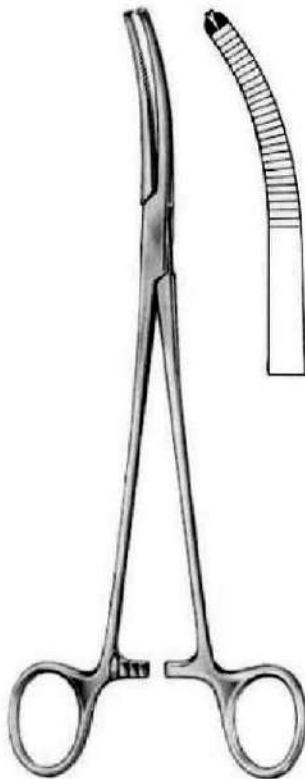

Mikulicz
07-2309-20
20 cm/8"

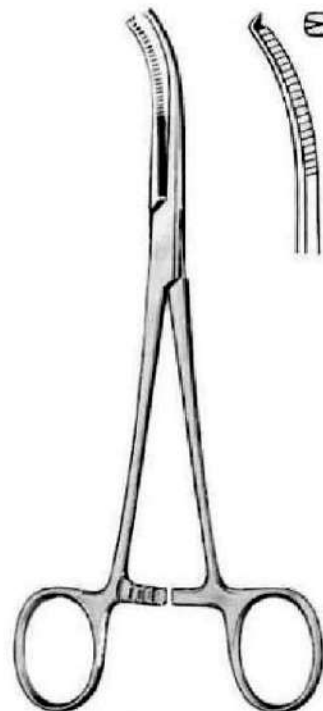

Mikulicz
07-2310-18
18.5 cm/7¼"

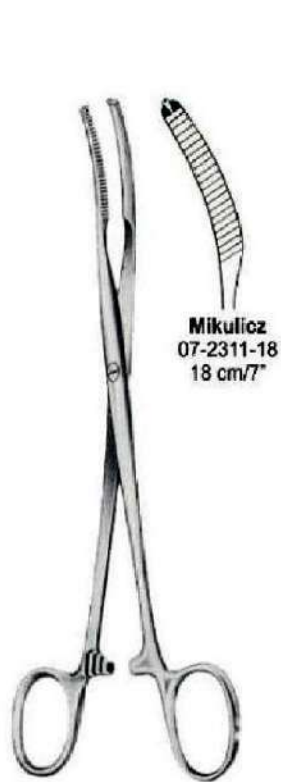

Mikulicz
07-2311-18
18 cm/7"

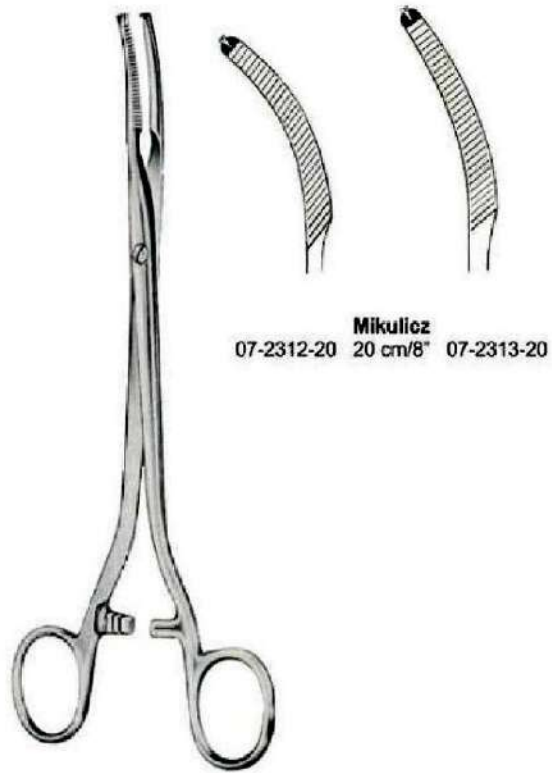

Mikulicz
07-2312-20 20 cm/8" 07-2313-20

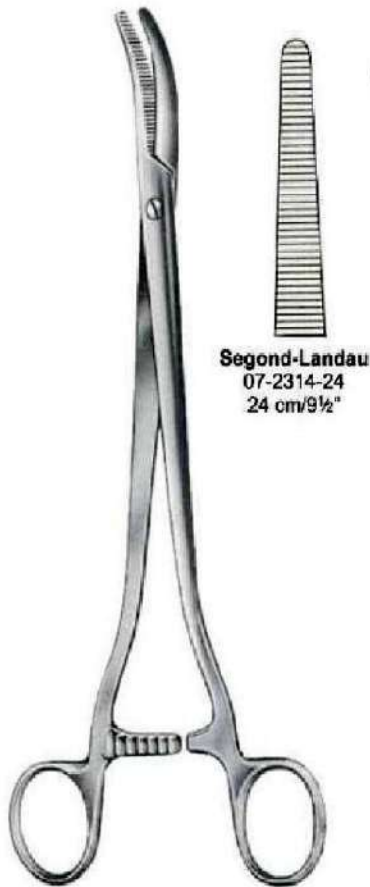

Segond-Landau
07-2314-24
24 cm/9½"



Segond
07-2315-24
24 cm/9½"



Faure
07-2316-20 20 cm/8" 07-2317-20



Schindler
07-2318-20
20 cm/8"



Schadel
07-2319-09
9 cm/3½"



Jones
07-2320-05 5 cm/2"
07-2320-09 9 cm/3 ½"



Engl-Modell
07-2321-09
9 cm/3½"



Backhaus
07-2322-09 9 cm/3 ½"
07-2322-11 11 cm/4 ½"
07-2322-13 13 cm/5"
07-2322-15 15 cm/6"

With clip for Tubing or Cable



07-2323-11 11 cm/4 ½"
07-2323-13 13 cm/5"



Peers-Bertram
07-2324-14
14.5 cm/5¾"



Tohoku
07-2325-10 10 cm/4"
07-2325-13 13 cm/5"



Roder
07-2326-13 13 cm/5"
07-2326-15 15 cm/6"



Lorna
07-2327-10 10 cm/4"
07-2327-13 13 cm/5"



Bernhard
07-2328-16 16.5 cm/6 1/2"



Lane
07-2329-20
20 cm/8"



Doyen
07-2330-18
18 cm/7"



07-2331-14 14 cm/5 1/2"
07-2331-15 15 cm/6"
07-2331-18 18 cm/7"
07-2331-20 20 cm/8"



07-2332-14
14.5 cm/5 3/4"

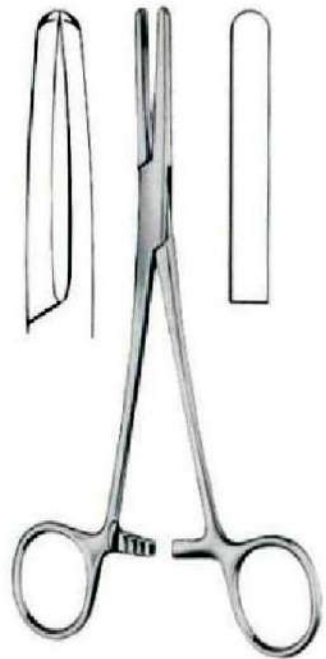

07-2333-16 16.5 cm/6 1/2"
07-2333-18 18.0 cm/7"



07-2334-15 15 cm/6"
07-2334-18 18 cm/7"
07-2334-20 20 cm/8"



Mohr
07-2335-50 50 mm
07-2335-60 60 mm
07-2335-70 70 mm
07-2335-80 80 mm

Sizes
mm
13
17
20
25
30



Hoffmann
07-2336-13
07-2336-17
07-2336-20
07-2336-25
07-2336-30



Hoffmann
07-2337-13
07-2337-17
07-2337-20
07-2337-25
07-2337-30



Ulrich

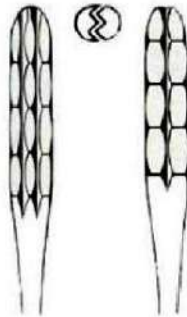

Straight

- 08-2401-22
- 08-2401-25
- 08-2401-27

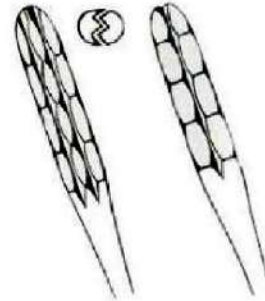

Curved

- | | |
|---------------|------------|
| 22 cm/8 3/4" | 08-2402-22 |
| 25 cm/10" | 08-2402-25 |
| 27 cm/10 1/2" | 08-2402-27 |



Lister

- | | | |
|------------|----------|------------|
| 08-2403-13 | 13 cm/5" | 08-2404-13 |
| 08-2403-15 | 15 cm/6" | 08-2404-15 |
| 08-2403-18 | 18 cm/7" | 08-2404-18 |



Bryant

- 08-2405-13
- 13 cm/5"

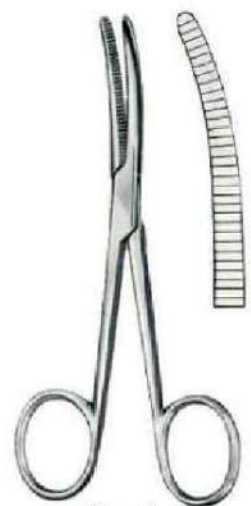

Bryant

- 08-2406-13
- 13 cm/5"



Gross-Maier



Straight



Curved

With Ratchet

08-2407-20	20 cm/8"	08-2408-20
08-2407-25	25 cm/10"	08-2408-25

Without Ratchet

08-2409-20	20 cm/8"	08-2410-20
08-2409-25	25 cm/10"	08-2410-25



Pelkmann
25 cm/10"



08-2411-25



08-2412-25



Sims-Maier
28 cm/11"



08-2413-28



08-2414-28



Duplay
20 cm/8"



08-2415-20



08-2416-20

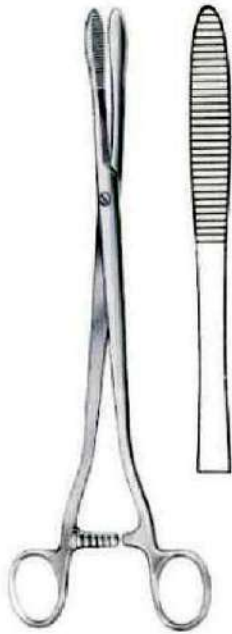

Collin
08-2417-25
25cm/10"



Cheron
08-2418-25
25cm/10"



Emmet
08-2419-21
21cm/8 1/4"



Bozemann
08-2420-26
26cm/10 1/4 "



Bozemann
26cm/10 1/4 "



08-2421-26



Smooth

08-2422-26



Bozemann-Douglas
08-2423-26
26cm/10 1/4"



Rampley
08-2424-18 18cm/7"
08-2424-24 24cm/9 1/2"



Rampley
08-2425-18 18cm/7"
08-2425-24 24cm/9 1/2"



Foerster

- 18 cm/7"
- 20 cm/8"
- 24 cm/9 1/2"
- 25 cm/10"



- 06-2426-18
- 06-2426-20
- 06-2426-24
- 06-2426-25

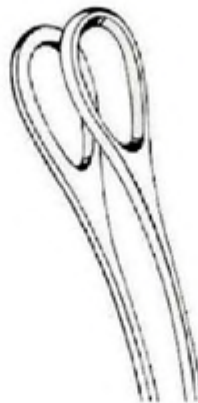

- 08-2427-18
- 08-2427-20
- 08-2427-24
- 08-2427-25



- 08-2428-18
- 08-2428-20
- 08-2428-24
- 08-2428-25



- 08-2429-18
- 08-2429-20
- 08-2429-24
- 08-2429-25



Derf
09-2501-12 12.0cm



Derf
09-2502-12 12.5cm



Collier
09-2503-12 12.5cm

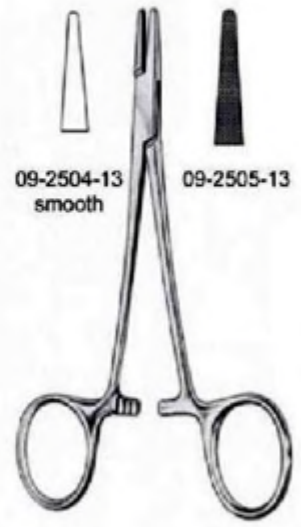

09-2504-13 smooth
09-2505-13
Webster
13.0cm



Halsey
09-2506-13 13.0cm 09-2507-13

smooth jaws with special groove



Neivert
09-2508-13 13.0cm



Hegar-Baumgartner
09-2509-12 12.5cm
09-2509-14 14.0cm



Brown
09-2510-13 13.0cm
09-2510-18 18.0cm



Mayo-Hegar
09-2511-14 14.0cm 09-2512-14
09-2511-15 15.0cm 09-2512-15
09-2511-16 16.0cm 09-2512-16
09-2511-18 18.0cm 09-2512-18
09-2511-20 20.0cm 09-2512-20
09-2511-22 22.0cm 09-2512-22
09-2511-24 24.0cm 09-2512-24
09-2511-26 26.0cm 09-2512-26
09-2511-28 28.0cm 09-2512-28
09-2511-30 30.0cm 09-2512-30



Mayo-Hegar
09-2513-16 16.0cm
09-2513-18 18.0cm
09-2513-20 20.0cm



Crile-Murray
09-2514-15 15.0cm



Crile-Wood
09-2515-15 15.0cm
09-2515-18 18.0cm
09-2515-20 20.0cm



Hegar
09-2516-20 20.0cm 09-2517-20
09-2516-24 24.0cm 09-2517-24



Adson
09-2518-18 18.0cm



Heaney
09-2519-21 21.0cm



Metzenbaum
09-2520-18 18.0cm



Wangensteen
09-2533-27 27.0cm



Jamison
09-2534-23 23.5cm

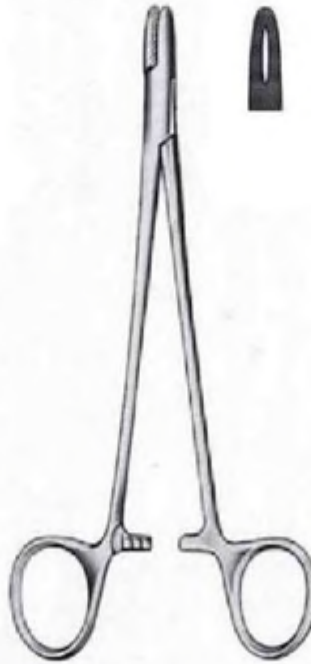

M.G.H. (mass-general-hospital)
09-2535-17 17.0cm



Gillies
09-2536-16 16.0cm (right hand)
09-2536-16 16.0cm (left hand)

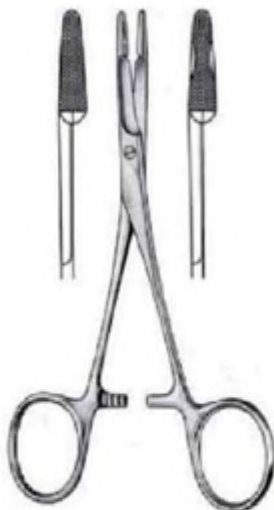

Olsen-Hegar
09-2537-14 14.0cm 09-2538-14
with blood groove



Olsen-Hegar
09-2539-17 17.0cm



Olsen-Hegar
09-2540-17 17.0cm



Olsen-Hegar
09-2541-14 14.0cm
09-2541-18 18.0cm



Crile
09-2542-15 15.0cm



Toennis
09-2543-18 18.0cm



Lichtenberg
09-2544-20 20.0cm



Macphail
09-2545-14 14.0 cm
09-2545-16 16.0cm
09-2545-18 18.0cm
09-2545-20 20.0cm



Mathieu
09-2546-14 14.0cm 09-2547-14
09-2546-17 17.0cm 09-2547-17
09-2546-20 20.0cm 09-2547-20
09-2546-24 24.0cm 09-2547-24



Mathieu
09-2548-14 14.0cm
09-2548-17 17.0cm



Mathieu
09-2549-17 17.0cm
09-2549-20 20.0cm



Castroviejo
14cm/5 1/2"

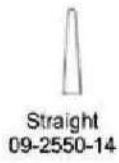

Castroviejo



Castroviejo
9cm/3 1/2"



Castroviejo
14cm/5 1/2"





Castroviejo
9 cm/3 1/2"



Castroviejo
14 cm/5 1/2"



Paton
09-2560-11
11.5 cm/4 1/2"



Jacobson

cm	in	Without ratchet	With ratchet
18	7"	09-2561-18	09-2562-18
21	8 1/4"	09-2561-21	09-2562-21



Straight
09-2563-15
15 cm/6"



Curved
09-2564-15
15 cm/6"



Straight
09-2565-18
18 cm/7"



Curved
09-2566-18
18 cm/7"



Straight
09-2567-18
18 cm/7"



Straight



09-2568-18
09-2568-22

Curved



09-2569-18
09-2569-22

Yasargil
18.0 cm/7"
22.5 cm/8¾"



Straight
09-2570-15
15 cm/6"



Curved
09-2571-15
15 cm/6"



Straight
09-2572-15
15 cm/6"



Curved
09-2573-15
15 cm/6"



Straight
09-2574-18
18.5 cm/7 1/4"



Curved
09-2575-18
18.5 cm/7 1/4"



Straight
09-2576-18
18.5 cm/7 1/4"



Curved
09-2577-18
18.5 cm/7 1/4"



23 cm/9"



Straight
09-2578-23



Curved
09-2579-23



Straight
09-2580-12
12 cm/4 3/4"



Curved
09-2581-12
12 cm/4 3/4"



Angled
09-2582-12
12 cm/4 3/4"



Straight
09-2583-12
12 cm/4 3/4"



Curved
09-2584-12
12 cm/4 3/4"



Angled
09-2585-12
12 cm/4 3/4"



Arruga
14 cm/5½"

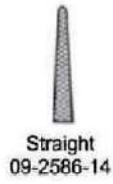

Straight
09-2586-14



Curved
09-2587-14



Stevens
09-2588-13 13 cm/5"
09-2588-15 15 cm/6"



Kalt
09-2589-14
14 cm/5½"



Castroviejo-Kalt
09-2590-13
13.5 cm/5¼"



Kalt-Arruga
09-2591-14
14 cm/5½"



Castroviejo

14cm/5½"
18cm/7"
21cm/8¼"



09-2631-14
09-2631-18
09-2631-21

Smooth



09-2632-14
09-2632-18
09-2632-21



14cm/5½"
18cm/7"
21cm/8¼"

09-2633-14
09-2633-18
09-2633-21



09-2634-14
09-2634-18
09-2634-21



Kalt
14cm/5½"



09-2635-14



09-2636-14



Barraquer
09-2637-14
14cm/5½"



Castroviejo
09-2638-13
13cm/5"



Hepp-Schiedel
18cm/7"



09-2639-18



09-2640-18

Smooth



Arruga
14cm/5½"



Straight
09-2641-14



Curved
09-2642-14



Jacobson
09-2643-18 18cm/7"
09-2643-20 20cm/8"
09-2643-23 23cm/8¾"



Diethrich

Straight		Curved
09-2644-16	16cm/6¼"	09-2645-16
09-2644-18	18cm/7"	09-2645-18
09-2644-20	20cm/8"	09-2645-20
09-2644-23	23cm/9"	09-2645-23
09-2644-25	25cm/10"	09-2645-25



Two rings angled



Neivert
09-2646-13
13 cm/5"



Neivert
09-2647-13
13 cm/5"



Webster
09-2648-13
13 cm/5"



Derf
09-2649-12
12.5 cm/5"



New Orleans
09-2650-18
18 cm/7"



Bozemann
09-2651-20 20 cm/8"
09-2651-24 24 cm/9 1/2"
09-2651-26 26 cm/10 1/2"



Mayo-Hegar

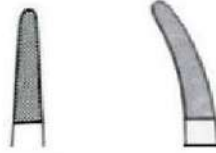

09-2652-16
09-2652-18
09-2652-20
09-2652-24
09-2652-26
09-2652-30

09-2653-20
09-2653-24
09-2653-26

16cm/6¼"
18cm/7"
20cm/8"
24cm/9½"
26cm/10½"
30cm/12"



Hegar-Baumgartner
09-2654-14
14cm/5½"



Mayo-Hegar
09-2655-20 20cm/8"
09-2655-24 24cm/9½"



De Bakey
09-2656-18 18cm/7"
09-2656-20 20cm/8"
09-2656-23 23cm/9"
09-2656-26 26cm/10½"
09-2656-31 31cm/12¼"



De Bakey-Fine
09-2657-18
09-2657-20
09-2657-23
09-2657-26
09-2657-31



Baby-Crile-Wood
09-2658-15
15cm/6"

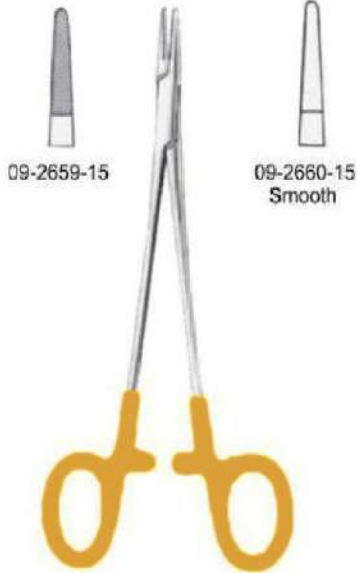

Crile-Wood
15cm/6"



Crile-Wood

	cm	in
09-2661-18	18	7"
09-2661-20	20	8"
09-2661-23	23	9"
09-2661-26	26	10 1/4"
09-2661-31	31	12 1/4"

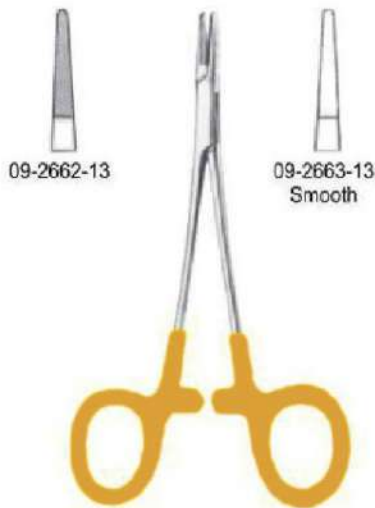

Halsey
13cm/5"



Converse
09-2664-12
12.5cm/5"

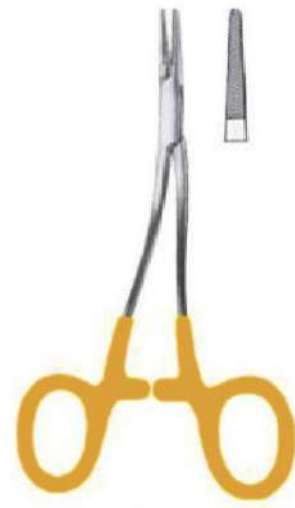

Kilner
09-2665-13
13.5cm/5 1/4"



Hegar-Vascular
09-2666-14 14cm/5½"
09-2666-18 18cm/7"
09-2666-20 20cm/8"
09-2666-23 23cm/9"



Ryder		Micro-Ryder	
09-2667-13		09-2668-13	13cm/5"
09-2667-15		09-2668-15	15cm/6"
09-2667-18		09-2668-18	18cm/7"
09-2667-20		09-2668-20	20cm/8"
09-2667-23		09-2668-23	23cm/9"
09-2667-26		09-2668-26	26cm/10¼"



(Swedish Pattern)
09-2669-15 15cm/6"
09-2669-17 17cm/6¾"
09-2669-20 20cm/8"



Sarot
09-2670-18 18cm/7"
09-2670-26 26cm/10¼"



Stratte
09-2671-23
23cm/9"



Masson
09-2672-27
27cm/10½"



Wangenstein
09-2673-27
27cm/10½"



Finocchetto
09-2674-20 20cm/8"
09-2674-27 27cm/10½"



Mathieu

14cm/5½"	09-2675-14
17cm/6¾"	09-2675-17
20cm8"	09-2675-20
24cm/9½"	09-2675-24



Mathieu

09-2676-14
09-2676-17
09-2676-20
09-2676-24



Mathieu-Ryder

09-2677-17
09-2677-20



Langenbeck

16cm/6¼"	09-2678-16
18cm/7"	09-2678-18
20cm/8"	09-2678-20



Langenbeck-Ryder

09-2679-18
09-2679-20



Lichtenberg

09-2680-20



Toennis
09-2681-18
18 cm/7"



Mathieu-Kocher
09-2682-14 14 cm/5 1/2"
09-2682-17 17 cm/6 3/4"
09-2682-20 20 cm/8"



Axhausen
09-2683-18
18.5 cm/7 1/4"



Zweifel
09-2684-20 20 cm/8"
09-2684-23 23 cm/9"



09-2685-20 20 cm/8"
09-2685-25 25 cm/10"



Mathieu
09-2686-20 20 cm/8"
09-2686-24 24 cm/9 1/2"



Metzenbaum
09-2687-17 17 cm/6 3/4"
09-2687-20 20 cm/8"



Arruga
16 cm/6 1/4"

09-2688-16



09-2689-16



Boynton
09-2690-12
12 cm/4 3/4"



Hosel
09-2691-20 20 cm/8"
09-2691-25 25 cm/10"

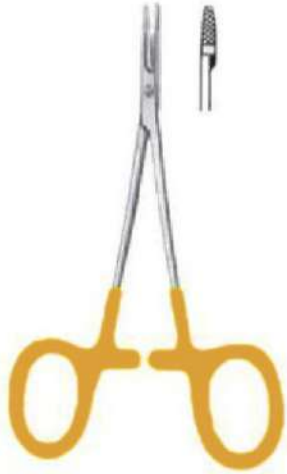

Baby-Olsen-Hegar
09-2692-11
11.5 cm/4 1/2"



Olsen-Hegar
09-2693-14
14 cm/5 1/2"



Olsen-Hegar
09-2694-17
17 cm/6 3/4"



Olsen-Hegar
09-2695-18
18 cm/7"



Gillies-Slim
09-2696-14
14.5 cm/5 1/2"



Gillies
09-2697-16 (right hand)
09-2698-16 (left hand)
16 cm/6 1/4"



Martin
12-3762-19
19 cm/7½"



Preston
12-3763-18
18 cm/7¼"

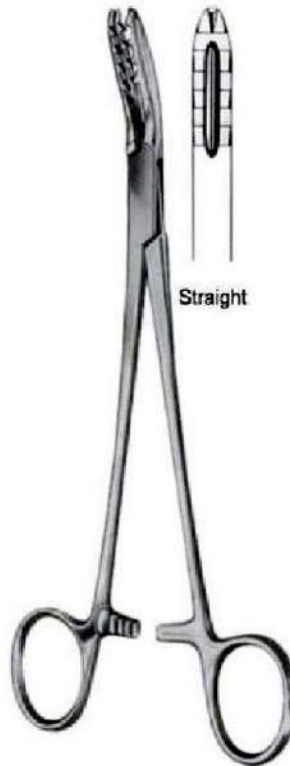

Bircher-Ganske
12-3764-20
20 cm/8"

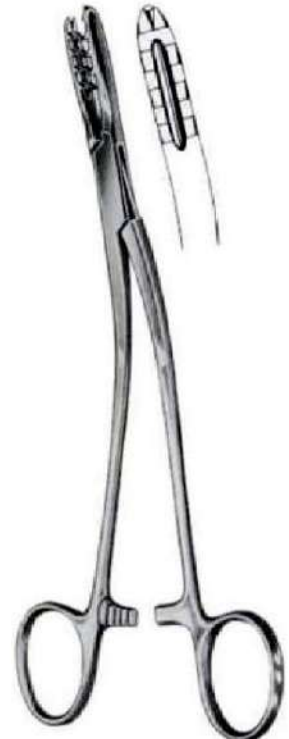

Bircher-Ganske
12-3765-20
20 cm/8"



Lewin
12-3766-17
17.5 cm/7"



Langenbeck
12-3767-21
21 cm/8¼"



Fergusson
12-3768-21
21 cm/8¼"

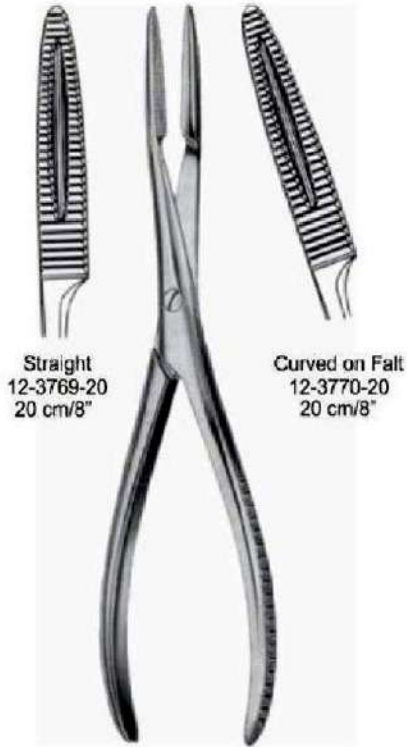

Straight
12-3769-20
20 cm/8"

Curved on Falt
12-3770-20
20 cm/8"



Van Buren
12-3771-23
23 cm/9"



Dingmann
12-3772-19
19cm/7½"



Dingmann Modif
12-3773-19
19 cm/7½"



Neff
12-3774-21
21 cm/8¼"



Semb
12-3775-19
19 cm/7½"



Semb
12-3776-19
19 cm/7½"



Verbrugge
12-3777-17
17.5 cm/7"

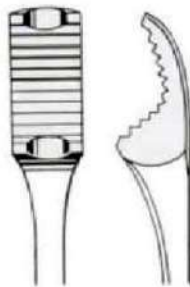

12-3778-25
25 cm/10"

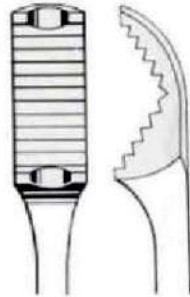

12-3779-26
26 cm/10¼"
Verbrugge

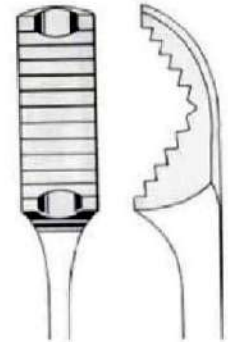

12-3780-27
27 cm/10½"



12-3781-16
16 cm/6¼"
12-3781-24
24 cm/9½"



Without Ratchet	Kern	With Ratchet
12-3782-17	17 cm 6¾"	12-3783-17
12-3782-21	21 cm 8¼"	12-3783-21



12-3784-18	18 cm/07"	12-3785-18
12-3784-23	23 cm/09"	12-3785-23
12-3784-25	25 cm/10"	12-3785-25
12-3784-28	28 cm/11"	12-3785-28



Hey Groves
12-3786-21 21.0 cm/8¼"
12-3786-27 27.0 cm/10½"
12-3786-30 30.5 cm/12"



Farabeuf-Lambotte
12-3787-26
26 cm/10¼"



Lambotte
12-3788-19 19 cm/7½"
12-3788-23 23 cm/9"
12-3788-26 26 cm/10¼"



Without Ratchet	Lane	With Ratchet
	cm in	
12-3789-33	33 13"	12-3790-33
12-3789-45	45 17¾"	12-3790-45



12-3791-14
14.5 cm/5¾"



12-3792-12
12 cm/4¾"



12-3793-15 15 cm/6"
12-3793-19 19 cm/7 1/2"
12-3793-24 24 cm/9 1/2"
12-3793-26 26 cm/10 1/4"
12-3793-28 28 cm/11"



Handles Detachable

Percy
12-3794-30

Adjustable



Lambotte
12-3795-22 22 cm/8 3/4"
12-3795-27 27 cm/10 1/2"
12-3795-30 30 cm/12"



Farabeuf
12-3796-23 23 cm/9"
12-3796-26 26 cm/10 1/4"



Lambotte
12-3797-22 22.5 cm/9"
12-3797-25 25.5 cm/10 1/2"
12-3797-33 33 cm/13 1/2"

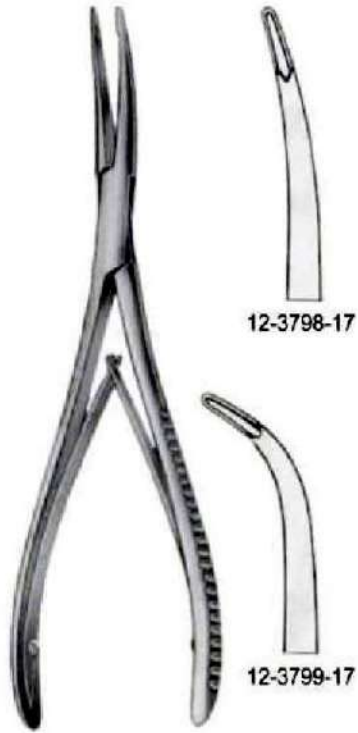

Stellbrink
17.5 cm/7"



Bane-Hartmann
12-3800-17
17.5 cm/7"



Mini-Friedmann
12-3801-12
12.5 cm/5"



Friedmann
12-3802-14
14 cm/5½"





12-3883-13 13 cm/5"
12-3883-18 18 cm/7"



12-3884-17
17 cm/6 3/4"

TC

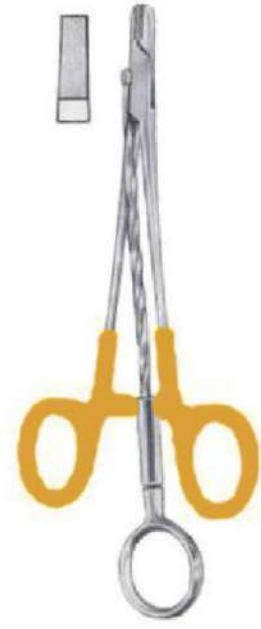

12-3885-15
15.5 cm/6"



12-3886-17 17 cm/6 3/4" 12-3887-17



12-3888-19
19 cm/7 1/2"



12-3889-14
14 cm/5½"



12-3890-16
16 cm/6¼"



18cm/7"

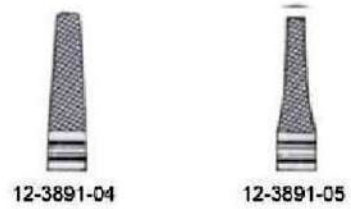
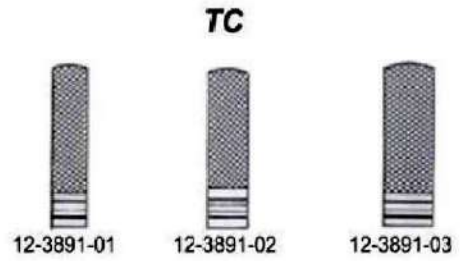

TC



12-3892-18 18 cm/7"
12-3892-20 20 cm/8"

TC



12-3893-16 15 cm/6"
12-3893-20 20 cm/8"

12-3894-16 15 cm/6"

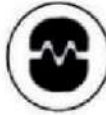

De Bakey

Coarctation Clamps



14-4139-21
21 cm/8¼"

14-4139-22
22 cm/8¾"

Potts
(De Bakey)



14-4140-21
21 cm/8¼"

14-4140-22
22 cm/8¾"

Potts
(De Bakey)



14-4141-21
21 cm/8¼"

14-4141-22
22 cm/8¾"

Potts



Glover
(Potts)

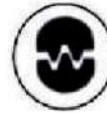

De Bakey

Anastomosis Clamps



14-4142-21
21 cm/8¼"

14-4142-22
22 cm/8¼"



**Dissecting and
Ligature Forceps**

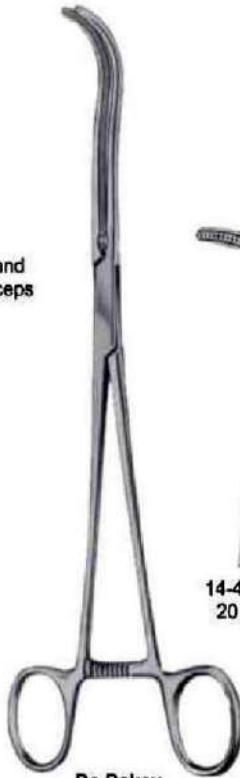

De Bakey



14-4143-20
20 cm/8"



14-4143-24
24 cm/9½"



De Bakey



14-4144-20
20 cm/8"



14-4144-18
18 cm/7½"

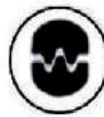

De Bakey



Leland-Jones



14-4145-01
19.5 cm/7½"



14-4145-02
19.5 cm/7½"



14-4145-03
19.5 cm/7½"



Leland-Jones
14-4146-18
18 cm/7"



Aortic Aneurysm Clamps



De Bakey



De Bakey



14-4147-24
24 cm/9½"



14-4147-27
27 cm/10½"



14-4147-31
31 cm/12¼"



14-4147-33
33.5 cm/13¼"



De Bakey-Bainbridge



14-4148-15
15 cm/6"



14-4148-18
18 cm/7"



14-4148-15
15 cm/6"



14-4148-18
18 cm/7"



De Bakey
14-4149-20
20 cm/8"



De Bakey

Aortic Aneurysm Clamps



De Bakey
14-4150-28
28 cm/11"



14-4151-30
30 cm/12"



De Bakey

Aortic Clamps



Ochsner
14-4152-23
23.5 cm/9 1/4"

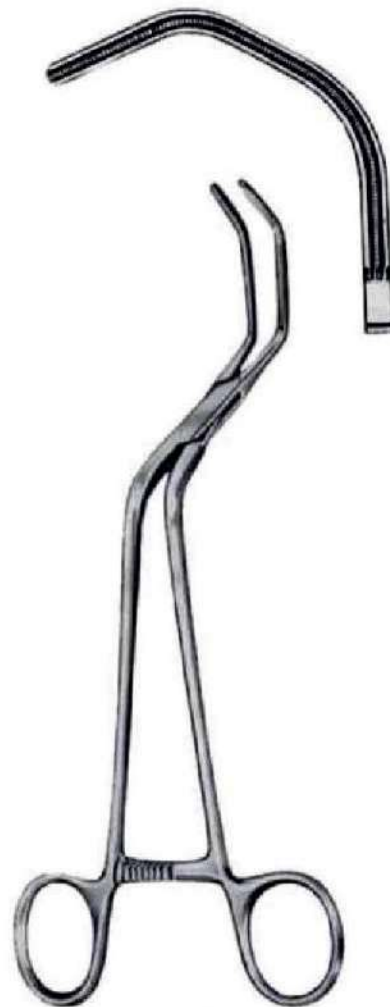

Dietrich
14-4153-21
21 cm/8 1/4"



De Bakey

Auricle Clamp



Harken



14-4154-01
24 cm/9½"



14-4155-02
24 cm/9½"



14-4156-03
24 cm/9½"



14-4157-04
24 cm/9½"



De Bakey

Bronchus Clamps

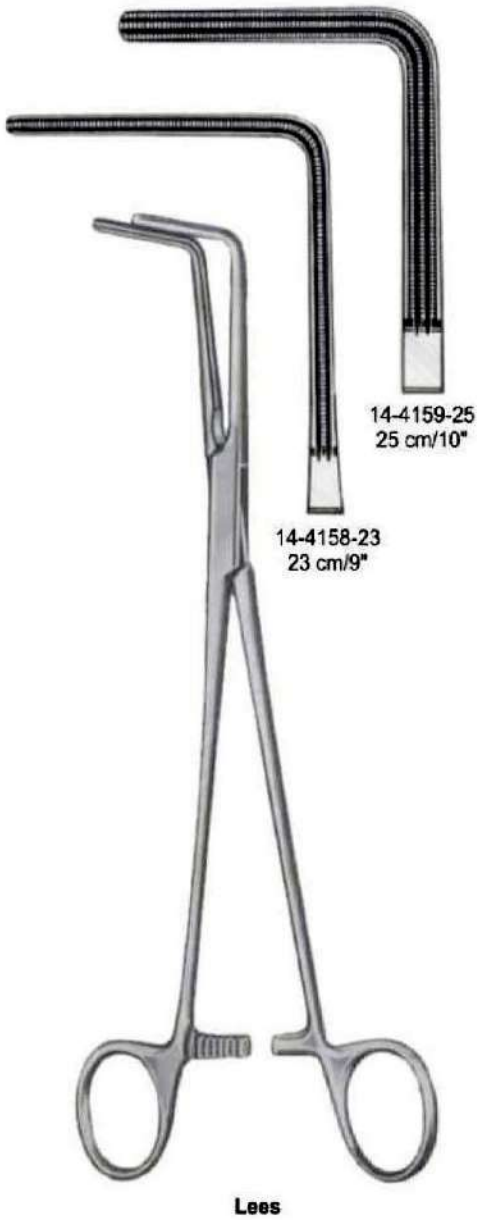

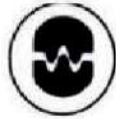

De Bakey

Aortic Clamp



Top View



De Bakey
14-4161-27
27 cm/10½"



De Bakey
14-4162-24
24 cm/9½"

Ligature Clamps



De Bakey
14-4163-24
24 cm/9½"



De Bakey

Ligature clamp,
Aortic clamp

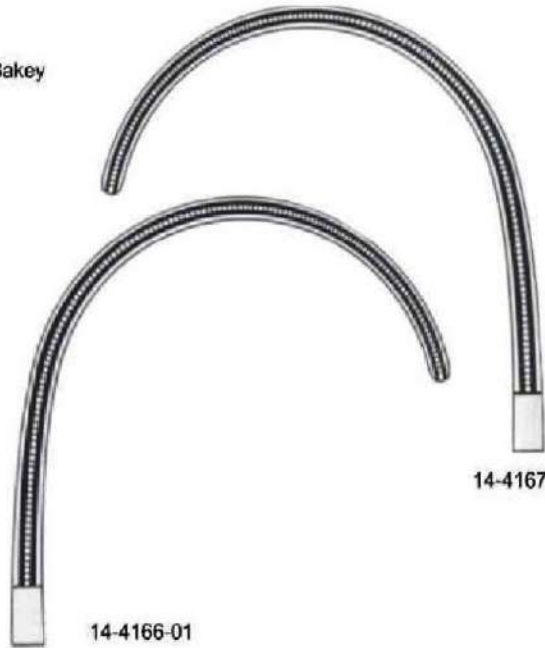

14-4167-02

14-4166-01



De Bakey
14-4165-26
26.5 cm/10½"

De Bakey-Semb
14-4164-25
25 cm/10"

Aortic clamp



Weber
26 cm/10¼"

De Bakey-Semb



Satinsky/De Bakey

Tangential occlusion clamps



De Bakey



Set of 5 purchase.
14-4168-00

14-4168-20
20 cm/8"

14-4168-25
25 cm/10"

14-4168-26
26 cm/10¼"

14-4168-27
27 cm/10½"

14-4168-28
28 cm/11"



Glover

14-4169-01 19.5 cm/7¾"
14-4169-02 21.0 cm/8¼"

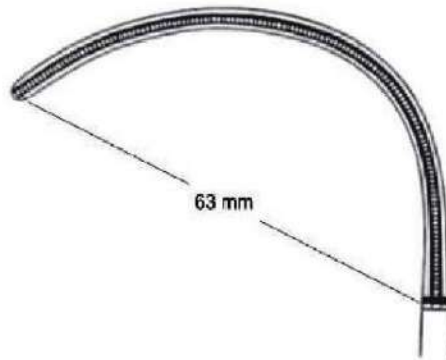

63 mm

Anastomosis

14-4169-01

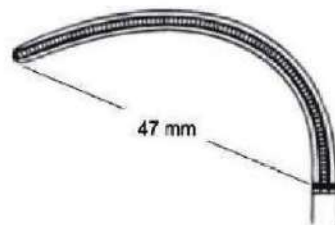

47 mm

14-4169-02



De Bakey



De Bakey
14-4170-16
16 cm/6 1/4"

Graduated



De Bakey-Beck
14-4171-01 20.5 cm/8"
14-4171-02 21.0 cm/8 1/4"

14-4171-02

14-4171-01



De Bakey



Lambert-Kay
21 cm/8 1/4"



Aortic anastomosis clamps

14-4172-21

14-4172-21



De Bakey
14-4173-17
17 cm/6 3/4"



Beck
14-4174-17
17 cm/6 3/4"





De Bakey



Multi purpose clamps



De Bakey

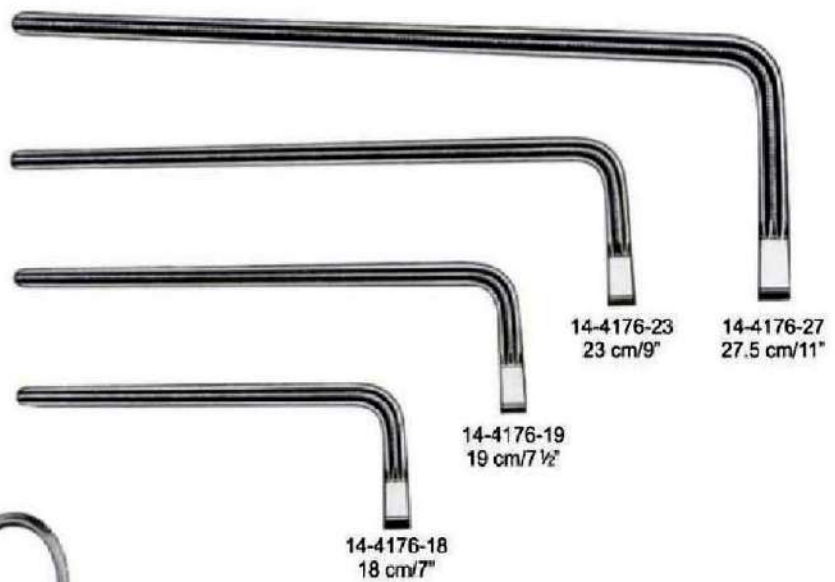



Aortic anastomosis clamps

Morris-De Bakey



14-4177-18
18 cm/7"

14-4177-20
20 cm/8"

14-4177-23
23 cm/9"

14-4177-25
25 cm/10"

Glover
14-4178-24
24.5 cm/9 3/4"



Aorta aneurysm clamps



De Bakey-Bahnson



De Bakey



14-4179-24
24.5 cm/9¾"



14-4179-25
25.5 cm/10"



14-4179-26
26.5 cm/10½"

Coarctation clamps



Straight	cm/in	Curved
14-4180-21	21.5 cm/8½"	14-4181-21
14-4180-23	23.0 cm/9"	14-4181-23
14-4180-27	27.0 cm/10½"	14-4181-27
14-4180-31	31.5 cm/12½"	14-4181-31



De Bakey

Multi purpose clamps



De Bakey-Rankin



14-4182-16
16 cm/6 1/4"

14-4182-16
16 cm/6 1/4"



Cooley

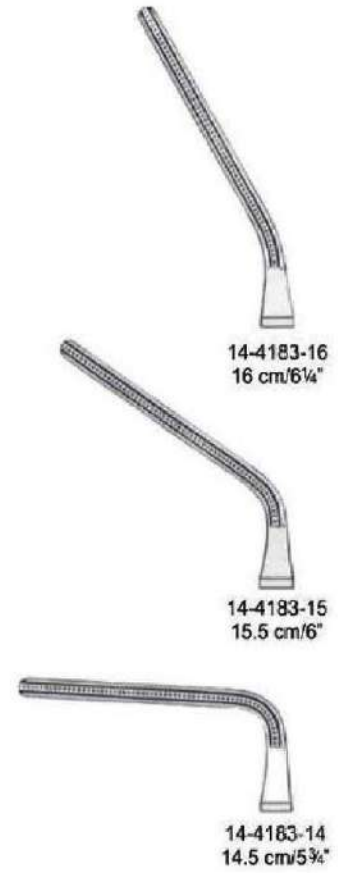

14-4183-16
16 cm/6 1/4"

14-4183-15
15.5 cm/6"

14-4183-14
14.5 cm/5 3/4"



De Bakey
14-4184-17
17 cm/6 3/4"

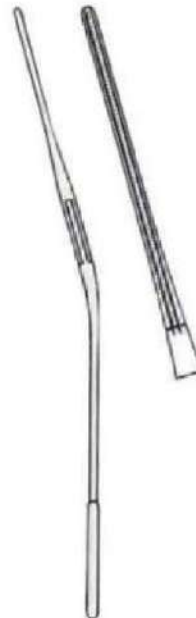

14-4185-17



14-4186-17



14-4187-17



De Bakey

Ligature Clamps

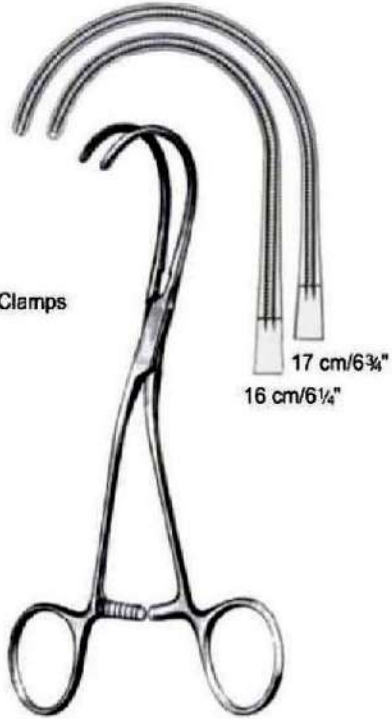

14-4188-16 16cm/6 1/4"
14-4188-17 17cm/6 3/4"



Derra-De Bakey
17 cm/6 1/4"



14-4189-01 14-4189-02 14-4189-03

Anastomosis Clamps

Profunda Clamps

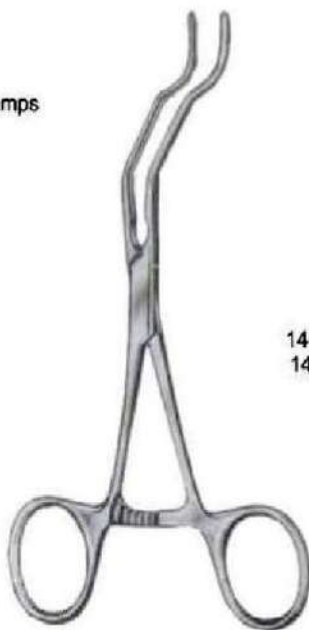

Gregory



14-4190-14
14 cm/5 1/2"



14-4190-16
16 cm/6 1/4"



14-4190-18
18 cm/7"



Cooley

Coarctation Clamps



Cooley
14-4191-17
17 cm/6¾"



14-4192-17
17 cm/6¾"



14-4193-17
17 cm/6¾"



14-4194-17
17 cm/6¾"

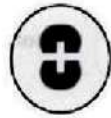

Cooley



Cooley
14-4195-20
20 cm/8"



Cooley



14-4196-03
17 cm/6³/₄"

14-4197-02
15.5 cm/6"



14-4198-01
15 cm/6"



Cooley
14-4199-17
17 cm/6³/₄"



Cooley

Anastomosis clamps



Cooley



14-4200-01
16.5 cm/6½"



14-4200-02
16.5 cm/6½"



14-4200-03
17.5 cm/7"



29-0980714-4200
17.5 cm/7"



Cooley
14-4201-16
16 cm/6¼"



Beck
14-4202-17
17 cm/6¾"



Cooley



Cooley-Derra

14-4203-16
16 cm/6 1/4"



14-4203-17
17 cm/6 3/4"



14-4203-18
18 cm/7"



Cooley

14-4204-16 16 cm/6 1/4"
14-4204-17 17 cm/6 3/4"



16 cm/6 1/4"

17 cm/6 3/4"

Ligature clamps



Cooley



14-4205-14



14-4206-14

Cooley
14 cm/5½"



Cooley
14-4207-14
14 cm/5½"



Cooley
14-4208-14
14 cm/5½"



Cooley
14-4209-14
14 cm/5½"



Birkett Artery Forcep
20-5405-18 Str.
20-5406-18 Cvd.
18cm/7"

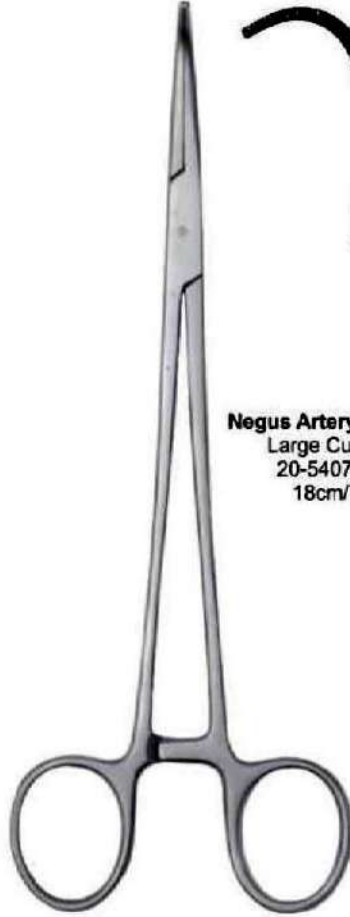

Negus Artery Forcep
Large Curved
20-5407-18
18cm/7"

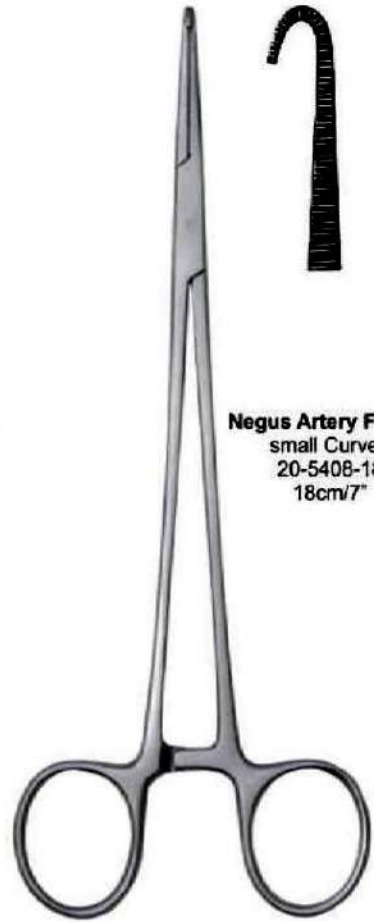

Negus Artery Forcep
small Curved
20-5408-18
18cm/7"



		Allis	
		4 : 5	5 : 6
cm	in		
15	6"	24-5801-15	24-5802-15
19	7½"		24-5802-19
23	9"		24-5802-23
25	10"		24-5802-25



		Baby-Allis	
		24-5803-12	12 cm/4¾"
		24-5803-14	14 cm/5½"



		Allis-Atrauma	
		24-5804-16	16 cm/6¼"
		24-5804-20	20 cm/8"
		24-5804-25	25 cm/10"
		24-5804-30	30 cm/12"



Allis-Adair
24-5805-15
15 cm/6"



Baby-Allis
24-5806-15
15 cm/6"



Lockwood-Allis
24-5807-16 16 cm/6¼"
24-5807-20 20 cm/8"



Thoms-Allis
24-5808-20
20 cm/8"

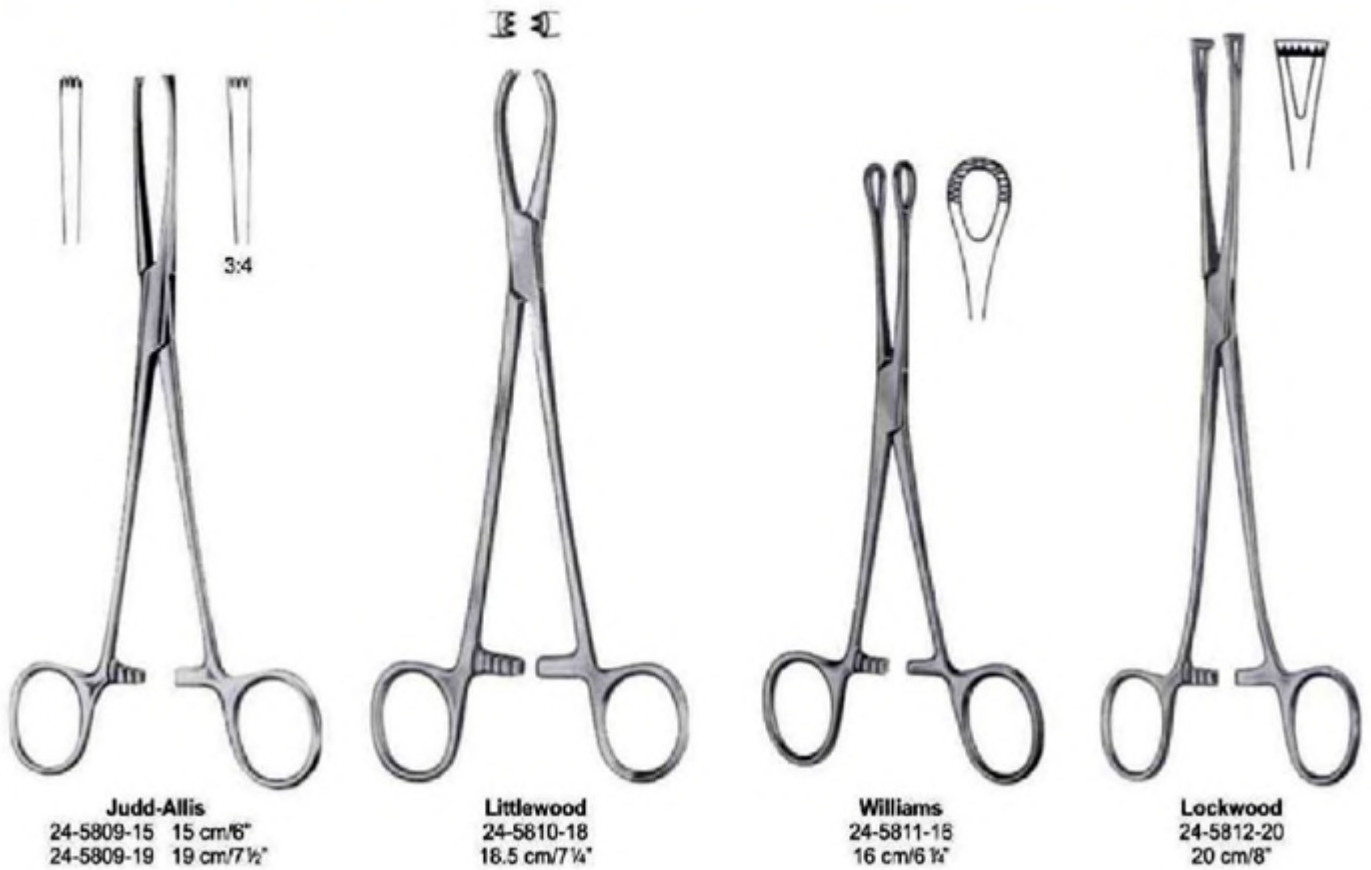

Atrauma





	Duval		
	cm	in	
24-5818-18	18	7"	
24-5818-20	20	8"	24-5819-20
24-5818-23	23	9"	24-5819-23



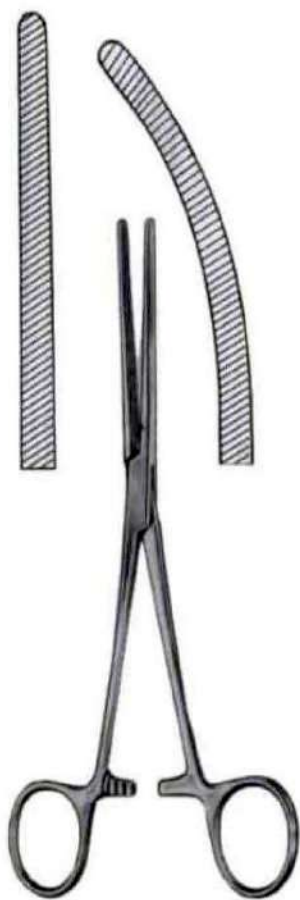

Baby-Doyen
Straight 24-5823-18 18 cm/7"
Curved 24-5824-18 18 cm/7"



Doyen
Straight 24-5825-21 21 cm/8 1/4
24-5825-23 23 cm/9"
Curved 24-5826-21 21 cm/8 1/4
24-5826-23 23 cm/9"



Scudder
24-5827-25 25 cm/10"



Doyen-Atrauma

Atrauma

Straight



Atrauma

Curved





**Mayo-Robson
Mayo-Robson Atrauma**



24-5830-21
21 cm/8 1/4"



24-5831-21
21 cm/8 1/4"



24-5832-23
23 cm/9"



24-5833-23
23 cm/9"

Atrauma



24-5834-25
25 cm/10"



24-5835-25
25 cm/10"



24-5836-25
25 cm/10"



24-5837-25
25 cm/10"



Resano
24-5838-30
30 cm/12"



Hayes



24-5839-26
26 cm/10 1/4"

Atrauma

24-5840-28
28 cm/11"

Atrauma



Fehland
24-5841-24
24 cm/9 1/2"



Brunner
24 cm/9 1/2"

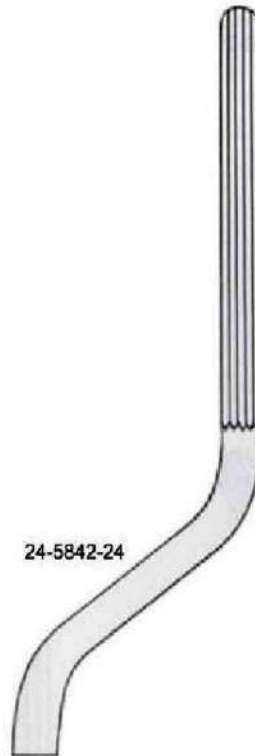

24-5842-24



24-5843-24

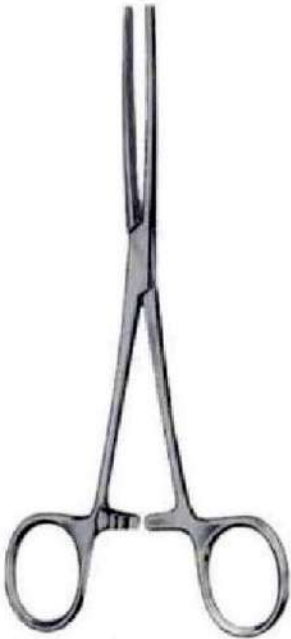

Straight 24-5844-13
13 cm/5"
Baby-Kocher 24-5845-13
13 cm/5"
Curved



Kocher



24-5846-22
22 cm/8 3/4"



24-5846-25
25 cm/10"



24-5846-28
28 cm/11"



24-5847-22
22 cm/8 3/4"



24-5847-25
25 cm/10"



24-5847-28
28 cm/11"

Atrauma



Kocher-Atrauma



24-5848-22
22 cm/8 3/4"



24-5848-25
25 cm/10"



24-5848-28
28 cm/11"



24-5849-22
22 cm/8 3/4"



24-5849-25
25 cm/10"



24-5849-28
28 cm/11"



Straight
24-5851-25



Nussbaum
25 cm/10"



Curved
24-5852-25



Pylorus spreader

Benson
24-5850-15
15.5 cm/6"



Allen
24-5853-15 15.5 cm/6"
24-5853-20 20.0 cm/8"



Kleinschmidt
24-5854-12
12 cm/4 3/4"

Blindgut forceps



Twin Clamps Forceps



Lane
30 cm/12"



Straight
24-5859-30

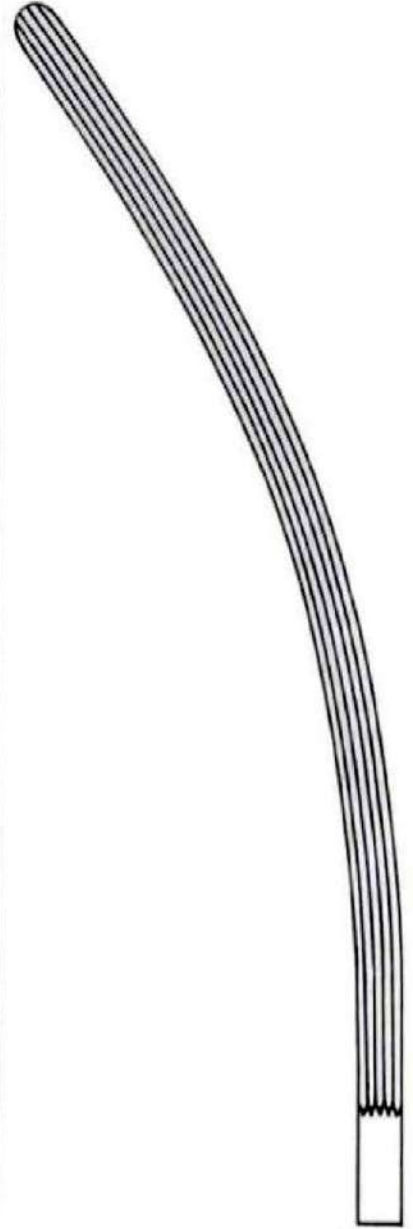

Curved
24-5860-30



Atrauma



**Scudder
Scudder-Atrauma**
33 cm/13"



Straight
24-5861-33

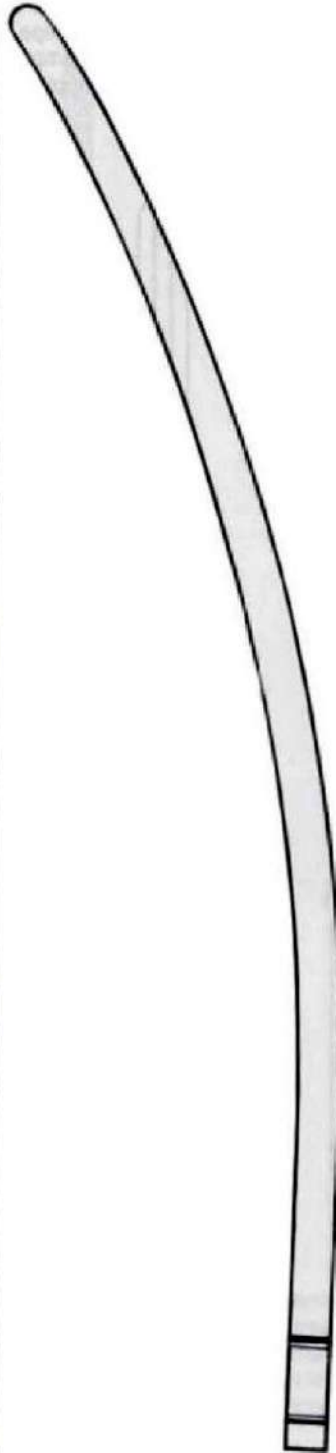

Curved
24-5862-33



Straight
24-5863-33

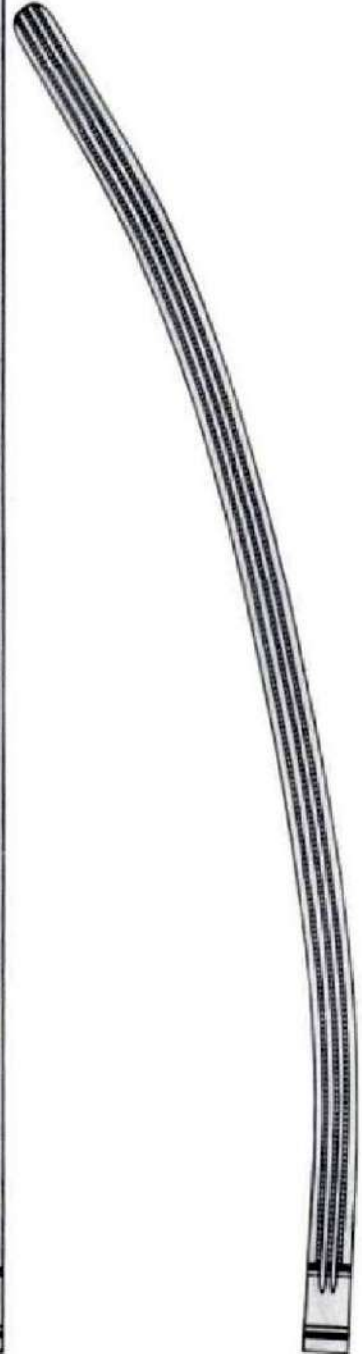

Curved
24-5864-33



Intestinal and Stomach Twin Clamps



Haberer
24-5865-36
36 cm/14"



Straight
24-5866-30

Nussbaum
30 cm/12"

Curved
24-5867-30



Atrauma



Guyon



25-6001-20
20 cm/8"

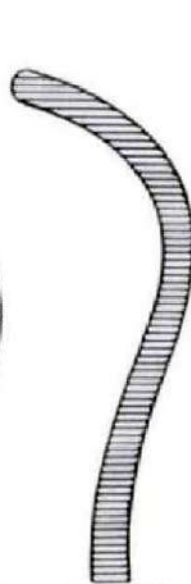

25-6001-22
22 cm/8 3/4"

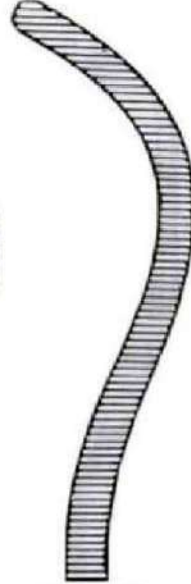

25-6001-24
24 cm/9 1/2"



25-6002-23
23 cm/9"



25-6002-24
24 cm/9 1/2"



Guyon
25-6003-23
23 cm/9"



Herrick
25-6004-23
23 cm/9"



Mayo-Guyon
25-6005-23
23 cm/9"



Stille
25-6006-23
23 cm/9"



Elsasser
25-6007-20
20 cm/8"



25-6008-20
20 cm/8"

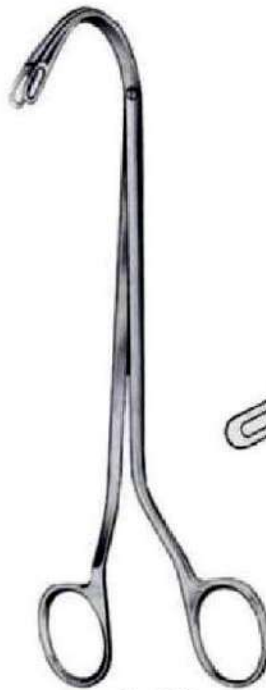

Randall



25-6009-01
19 cm/7½"



25-6009-02
19 cm/7½"



Randall

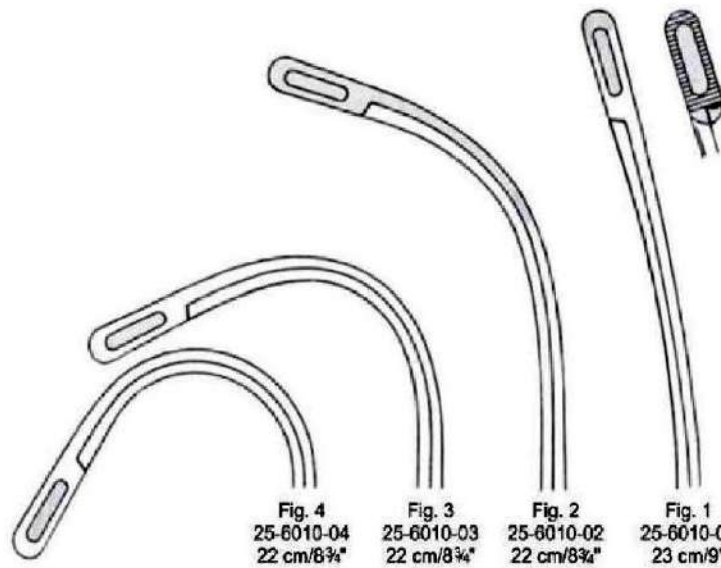

Fig. 4
25-6010-04
22 cm/8¾"

Fig. 3
25-6010-03
22 cm/8¾"

Fig. 2
25-6010-02
22 cm/8¾"

Fig. 1
25-6010-01
23 cm/9"



Gray
25-6011-00

Set of 2 pieces

Fig. 1
25-6011-01
22 cm/8¾"



Fig. 2
25-6011-02
23 cm/9"

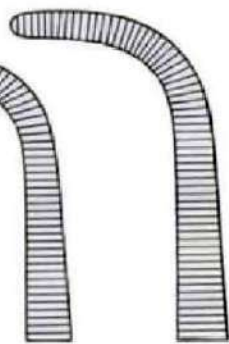

Gray
25-6012-00

Set of 2 pieces

Fig. 1
25-6012-01
22 cm/8¾"



Fig. 2
25-6012-02
23 cm/9"

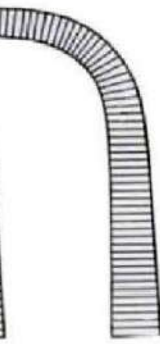

Gall duct and
cystic forceps



Desjardins
25-6013-21
21 cm/8½"

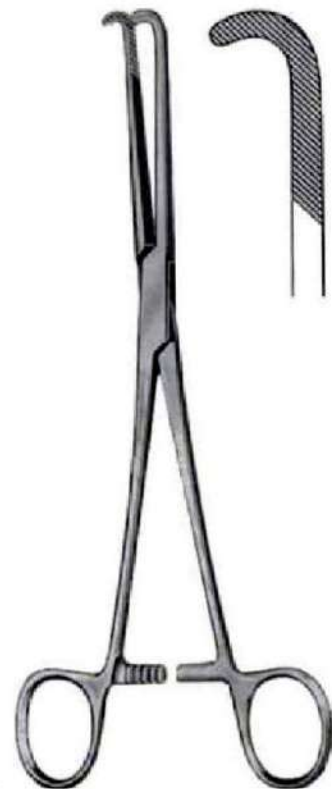

Nissen
25-6014-21
21.5 cm/8½"



Straight **Blake** Curved
25-6015-20 20 cm/8" 25-6016-20



Straight **Mayo-Blake** Curved
25-6017-20 20 cm/8" 25-6018-20



Czerny
25-6019-24
24.5 cm/9 3/4"



Desjardins
23 cm/9"

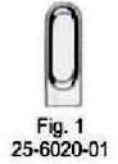

Fig. 1
25-6020-01



Fig. 2
25-6021-02



Martin
26-6256-27
27 cm/10½"



Staude-Moore
26-6257-17
17 cm/6¾"



Barrett
26-6258-18
18 cm/7"



Schroeder
26-6259-25
25 cm/10"



Braun
26-6260-25
25 cm/10"



Collin-Pozzi
26-6261-25
25 cm/10"



Pozzi
26-6262-25
25.5 cm/10¼"

Strong Pattern



Duplay
26-6263-28
28 cm/11"



Amniotome for the
amnion Bladder



Skene
26-6264-24
24 cm/9½"



Beacham
26-6265-26
26 cm/10¼"



Czerny
26-6266-20
20.5 cm/8¼"



26-6267-26
26 cm/10¼"



Schroeder
26-6268-20 20 cm/8"
26-6268-24 24 cm/9½"
Straight



Schroeder
26-6269-20
26-6269-24
Curved on Flat



Schroeder
26-6270-20
26-6270-24
Curved Sideway



Atrauma
26-6271-29
Vulsellum Forcep
29cm/11 ½"



Luer
26-6272-30
Vulsellum Forcep
30.5cm/12"



Atrauma
26-6273-29
29cm/11 1/2"



Bozeman
26-6274-27
27cm/10 1/2"



26-6275-23
23cm/9"
jaw 1/8"

26-6276-23
23cm/9"
jaw 1/4"

Atrauma



Rotunda
26-6277-27
27cm/10 1/2"



Bierer
26-6278-24
24cm/9 1/2"



Straight
26-6279-06
26-6279-08
26-6279-10



Museux
24 cm/9 1/2"
06 mm
08 mm
10 mm



Curved Sideway
26-6280-06
26-6280-08
26-6280-10



Straight
26-6281-06
26-6281-08
26-6281-10



Museux
24 cm/9 1/2"
06 mm
08 mm
10 mm



Curved Sideway
26-6282-06
26-6282-08
26-6282-10



Braun
26-6283-16
16 cm/6 1/4"

For the amnion Bladder



Pratt
26-6284-28
28 cm/11"



Teale
26-6285-24
24 cm/9½"



Iowa
26-6286-26
26 cm/10¼"



Jacobs
Straight Curved Sideway
26-6287-21 26-6288-21
21 cm/8¼"



Bonney Polypus
26-6289-26
24 cm/9 ½"



Kelly
26-6290-32
32 cm/12½"



Heywood-Smith
26-6291-20
20 cm/8"



Heywood-Smith
26-6292-25
25 cm/10"



Noto
26-6293-27
27 cm/10½"



Dartigues
26-6294-27
27 cm/10½"



Somer
26-6295-23
23 cm/9"



Collin
26-6296-25
25 cm/10"

Ovarian Forceps



Doyen
26-6297-18 18 cm/7"
26-6297-20 20 cm/8"



Bonney
26-6298-34
34.5 cm/13 ½"



Bonney
26-6299-27
27 cm/10½"



Bonney
26-6300-20
20 cm/8"
curved



Bonney Berkley
26-6301-20
20 cm/8"
angled



Gellhorn
26-6302-23
23 cm/9"



Thoms-Gaylor
26-6303-24
24 cm/9½"



Schubert
26-6304-21 21 cm/8 ¼"
26-6304-29 29 cm/11 ½"



Schubert
26-6305-26
26 cm/10 ¼"



Tischler
26-6306-27
27 cm/10½"



Van Doren
26-6307-25
25 cm/10"



Gwilliam

26-6308-20 20cm/8"
26-6309-20 20cm/8"



Hunter
26-6310-23
23 cm/9"

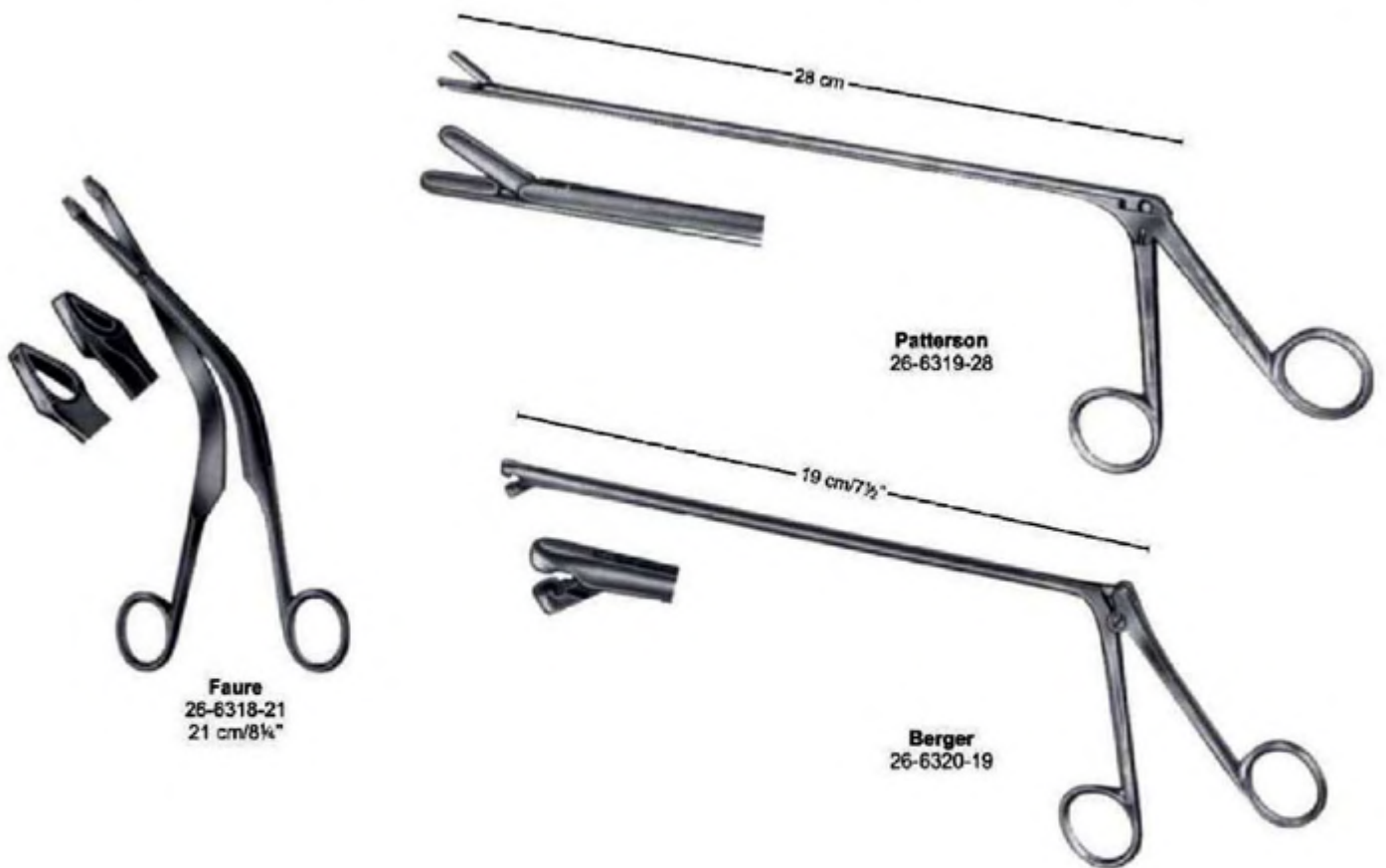



- 26-6321-20 L= 20 cm/8"
- 26-6321-25 L= 25 cm/10"
- 26-6321-30 L= 30 cm/12"
- 26-6321-35 L= 35 cm/14"
- 26-6321-40 L= 40 cm/16"

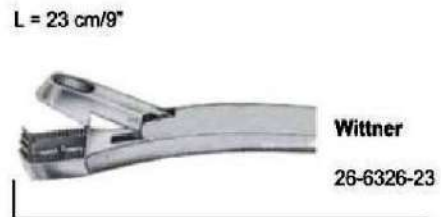
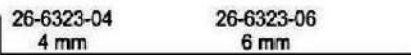
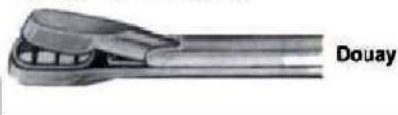



Tischler-Morgan
28-6327-20



Baby-Tischler
26-6328-20



Alexander
26-6329-28

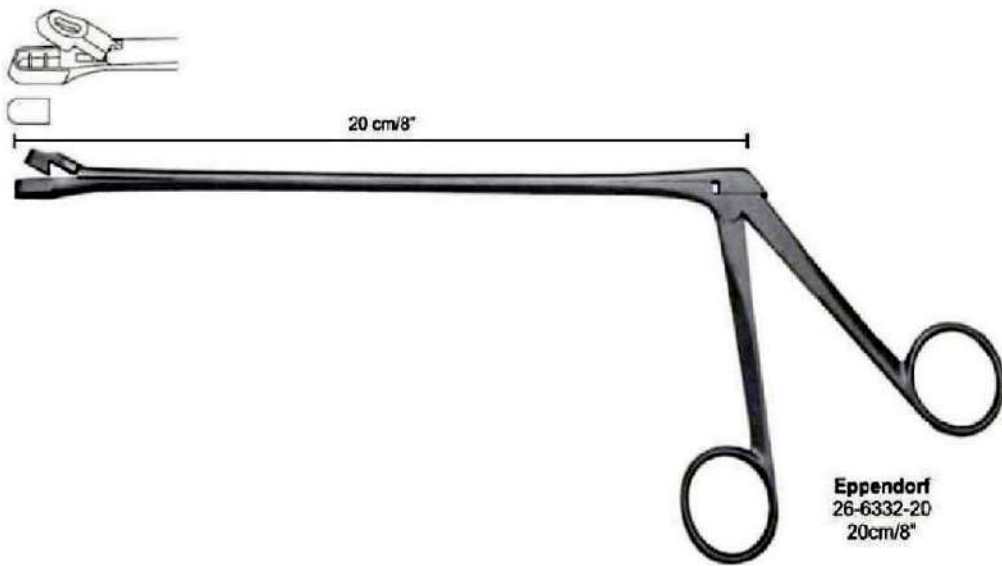
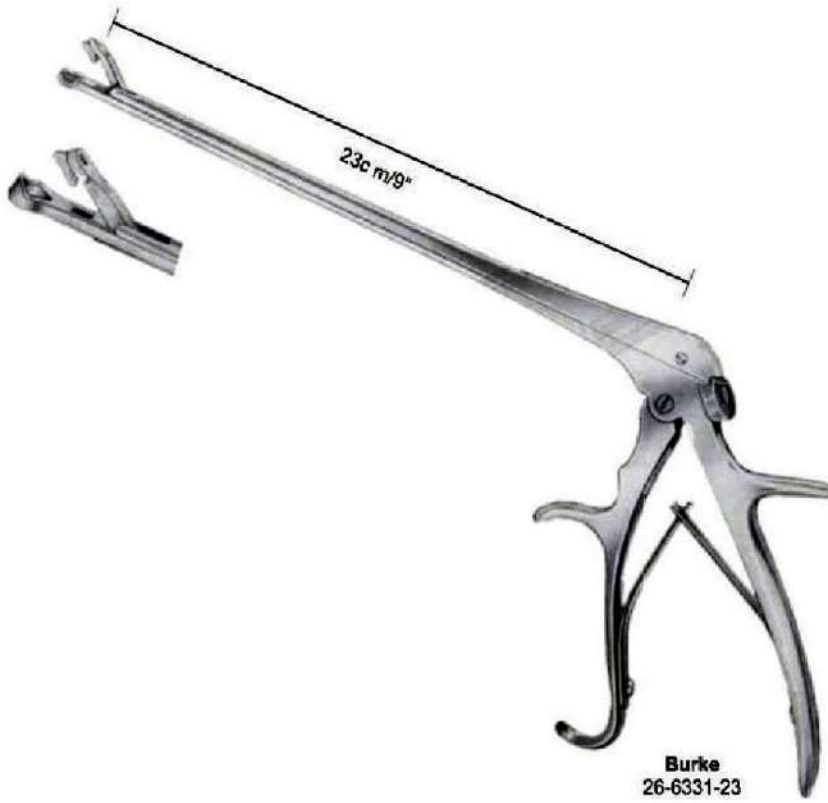













Handle

Townsend

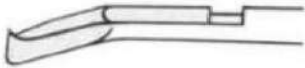

Tip with tube

		Complete instrument	Tip, only
	Tischler	26-6333-00	26-6334-01
	Kevorkian	26-6335-00	26-6336-01
	Mini-Townsend	26-6337-00	26-6338-01
	 Tischler-up	26-6339-00	26-6340-01
	 Tischler-down	26-6341-00	26-6342-01
	 Mini-Townsend-up	26-6343-00	26-6344-01
	 Mini-Townsend-down	26-6345-00	26-6346-01



Winter
28 cm/11"

Straight	27-6509-01	27-6509-02	27-6509-03
Curved	27-6510-01	27-6510-02	27-6510-03

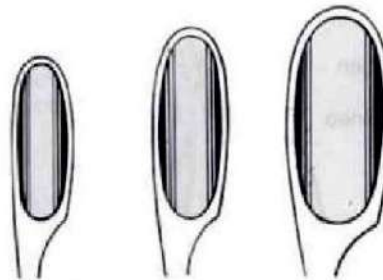

Wallich
27-6511-42
42 cm/16¾"



Sanger
21 cm/10½"

Straight
27-6512-27

Curved
27-6513-27

Uterine Haemostasis Forceps



Green-Armytage
27-6514-21
21 cm/8¼"



Nagele
27-6525-36 36 cm/14"
27-6525-40 40 cm/16"



Wrigley
27-6526-28
28 cm/11"



Simpson
27-6527-23
23 cm/9"



Simpson
27-6528-28 28cm/11"
27-6528-38 38cm/15"



Simpson-Braun
27-6529-36
36 cm/14"



Simpson-Luikart
27-6530-36
36 cm/14"



De Lee
27-6531-30 30 cm/12"
27-6532-36 36 cm/14"

Traction Handles to be used with all obstetrical Forceps with Standard type Handles



Bill
27-6533-20



Kielland
27-6534-41
41 cm/16"



Kielland-Luikart
27-6535-40
40 cm/15¾"



Mclean
27-6536-36
36 cm/14"



Elliot
27-6537-32 32 cm/12½"
27-6538-38 38 cm/15"



Piper
27-6539-44
44 cm/17 ¼"



With Traction Handle

Barnes-Neville
27-6540-43
43.5 cm/17"



With Traction Handle

Tarnier
27-6541-40
40 cm/15¾"



CHEATLE
28-6601-27 27.0cm



CHEATLE
28-6602-27 26.5cm



CHEATLE
28-6603-28 28.0cm



28-6604-20 20.0cm
28-6604-30 30.0cm

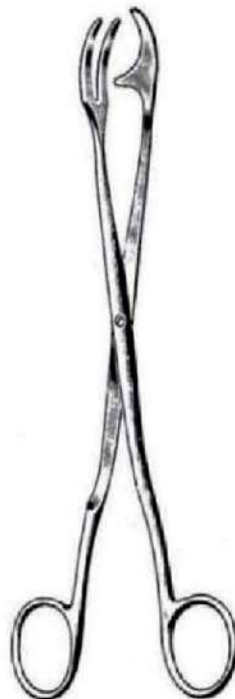

ROGGE
28-6605-23 23.0cm



DAVIS
28-6606-16 16.0cm
28-6606-20 20.0cm
28-6606-24 24.0cm



UNIVERSAL
28-6607-20 20.0cm
28-6607-28 28.0cm



UNIVERSAL
28-6608-20 20.0cm
28-6608-28 28.0cm



PYE-SMITH (HARRISON)
28-6609-25 25.0cm
28-6609-30 30.0cm



HARRISON
28-6610-25 25.0cm
28-6610-30 30.0cm
28-6610-35 35.0cm
28-6610-45 45.0cm



28-6611-00



BUNT
28-6612-12 12.0cm

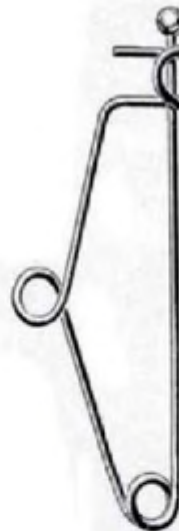

MAYO
28-6613-10 10.0cm
28-6613-12 12.0cm
28-6613-14 14.0cm
28-6613-15 15.0cm



MAYO
28-6614-14 14.0cm



025-503



025-504



025-505



025-513

025-514



025-515



025-516



025-517

Clamp forceps



200-042
Ivory lightweight
17 cm



200-043
Brewer
17.5 cm



200-044
Stoke
17.5 cm

Punch forceps



200-045
Ainsworth
17 cm



200-046
Ivory
17 cm

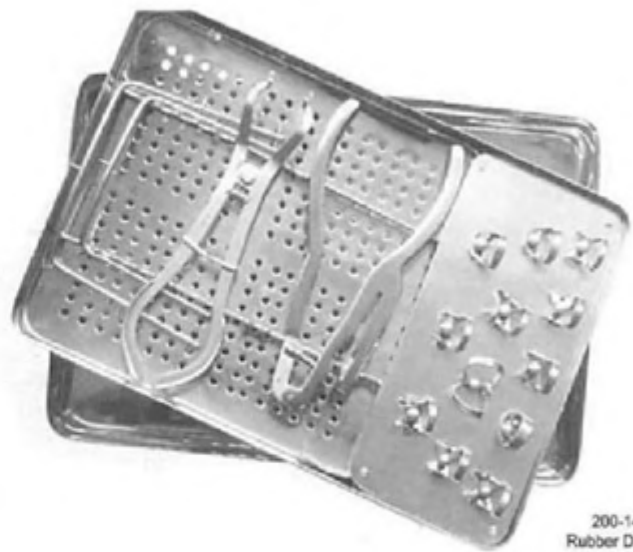

200-140
Rubber Dam Kit



200-143
Crown Remover Forceps
18 cm / 7"



200-137
17 cm
200-138
20 cm
Plaster Cutting Plier



200-145
Crown Plier



200-146
Crown Forceps



200-147
Crown Tweezer





Standard



Standard

06-1901-10	10.5cm
06-1901-11	11.5cm
06-1901-13	13.0cm
06-1901-14	14.5cm
06-1901-16	16.0cm
06-1901-18	18.0cm
06-1901-20	20.0cm
06-1901-23	23.0cm
06-1901-25	25.0cm
06-1901-30	30.0cm



Narrow

06-1902-10	10.5cm
06-1902-11	11.5cm
06-1902-13	13.0cm
06-1902-14	14.5cm
06-1902-18	16.0cm
06-1902-18	18.0cm
06-1902-20	20.0cm
06-1902-23	23.0cm
06-1902-25	25.0cm
06-1902-30	30.0cm



USA Model



06-1903-12	12.0cm
06-1903-13	13.0cm
06-1903-14	14.5cm
06-1903-15	15.0cm
06-1903-18	18.0cm
06-1903-21	21.0cm
06-1903-25	25.0cm
06-1903-31	31.0cm



06-1904-12	12.0cm
06-1904-13	13.0cm
06-1904-14	14.5cm
06-1904-15	15.0cm
06-1904-18	18.0cm
06-1904-21	21.0cm
06-1904-25	25.0cm



Stille
06-1905-15
15.0cm



Ochsner
06-1906-14
14.0cm



Treves
Turn over
06-1907-12 12.0cm
06-1907-15 15.0cm
06-1907-18 18.0cm
06-1907-20 20.0cm
06-1907-25 25.0cm



Treves
Block end
06-1908-12 12.0cm
06-1908-15 15.0cm
06-1908-18 18.0cm
06-1908-20 20.0cm
06-1908-25 25.0cm

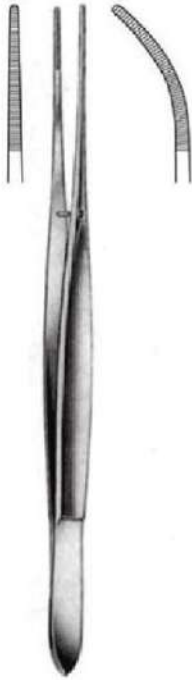

Cushing
06-1909-17 17.0cm 06-1910-17



Potts Smith
06-1911-18 18.0cm
06-1911-21 21.0cm
06-1911-25 25.0cm
06-1911-30 30.0cm



Waugh
06-1912-15 15.0cm
06-1912-18 18.0cm
06-1912-20 20.0cm



Brophy
06-1913-20 20.0cm 06-1914-20

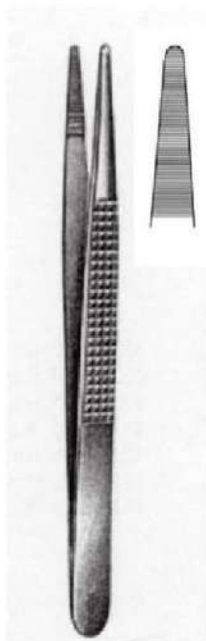

Bonney
06-1915-17
17.5cm



Ramsey
06-1916-18
18.0cm

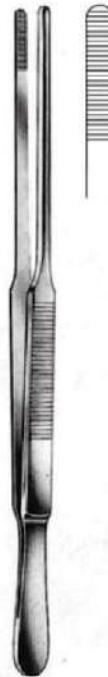

Duehrssen
06-1917-20
20.0cm



Wangenstein
06-1918-23
23.0cm



Adson
06-1919-12 12.0cm
06-1919-15 15.0cm
06-1919-19 19.0cm



McIndoe
06-1920-15 15.0cm



Semken
06-1921-12 12.0cm 06-1922-12
06-1921-15 15.0cm 06-1922-15



Gerald
06-1923-18 18.0cm



Gerald
06-1924-18 18.0cm



Gerald
06-1925-18 18.0cm



Taylor
06-1926-17 17.5cm Str
06-1927-17 17.5cm Cvd



Taylor
06-1928-17
18.5cm



Taylor
06-1929-17
17.5cm



Jefferson
06-1930-18
18.0cm, 180mm



Adson
06-1931-18
18.0cm, 180mm

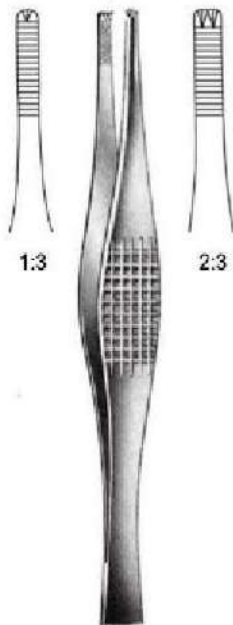

Ferris-Smith
06-1932-18 18.0cm 06-1933-18



Ramsay
18.0cm



Charnley
06-1936-18 18.0cm

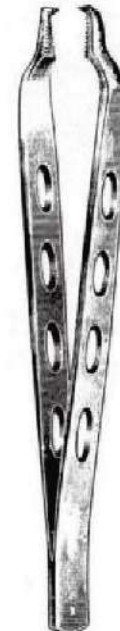

Jeans
06-1937-14 14.5cm
06-1937-17 17.5cm



Standard

	Slender 1:2	Delicate 1:2	Regular 1:2	2:3	3:4	4:5
10.0cm			06-1940-10	06-1941-10	06-1942-10	06-1943-10
11.0cm	06-1938-11		06-1940-11	06-1941-11	06-1942-11	06-1943-11
13.0cm	06-1938-13	06-1939-13	06-1940-13	06-1941-13	06-1942-13	06-1943-13
14.0cm	06-1938-14	06-1939-14	06-1940-14	06-1941-14	06-1942-14	06-1943-14
16.0cm	06-1938-16	06-1939-16	06-1940-16	06-1941-16	06-1942-16	06-1943-16
18.0cm	06-1938-18	06-1939-18	06-1940-18	06-1941-18	06-1942-18	06-1943-18
20.0cm	06-1938-20	06-1939-20	06-1940-20	06-1941-20	06-1942-20	06-1943-20
23.0cm			06-1940-23			
25.0cm			06-1940-25	06-1941-25	06-1942-25	06-1943-25
30.0cm			06-1940-30	06-1941-30	06-1942-30	06-1943-30



USA Model

12.0cm	06-1944-12			
13.0cm	06-1944-13	06-1945-13	06-1946-13	06-1947-13
14.0cm	06-1944-14	06-1945-14	06-1946-14	06-1947-14
15.0cm	06-1944-15	06-1945-15	06-1946-15	06-1947-15
18.0cm	06-1944-18			
21.0cm	06-1944-21			
25.0cm	06-1944-25			
31.0cm	06-1944-31			

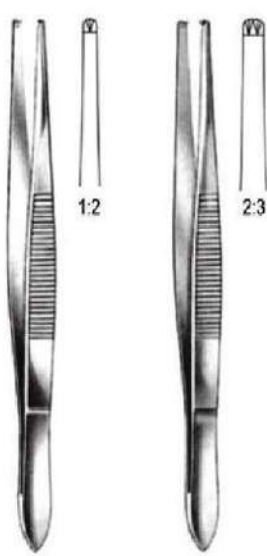

Stille
06-1948-15 15.0cm
06-1948-15 15.0cm



Treves
06-1949-12 12.5cm
06-1949-15 15.0cm
06-1949-18 18.0cm
06-1949-20 20.0cm
06-1949-25 25.0cm



Adlerkreutz



2:3
06-1950-15 15.0cm

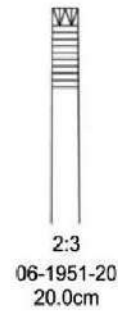

2:3
06-1951-20 20.0cm



4:5
06-1952-15 15.0cm



4:5
06-1953-20 20.0cm

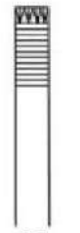

4:5
06-1954-25 25.0cm

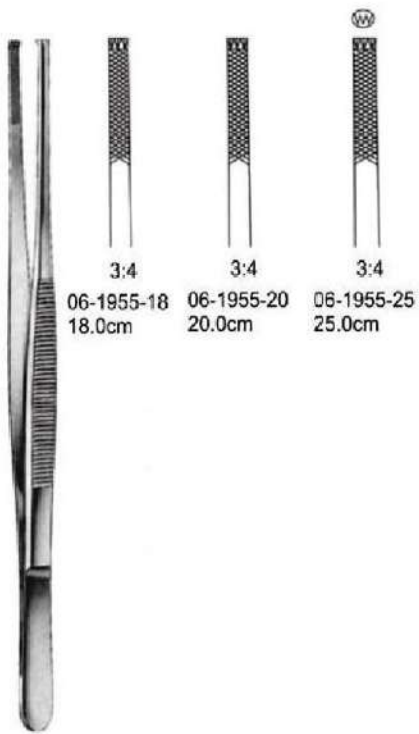

Stille-Barraya



Brophy
06-1956-20 20.0cm 06-1957-20

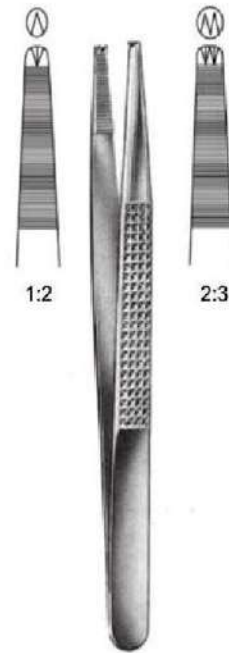

Bonney
06-1958-18 18.0cm 06-1959-18



Adson
06-1960-18 18.0cm

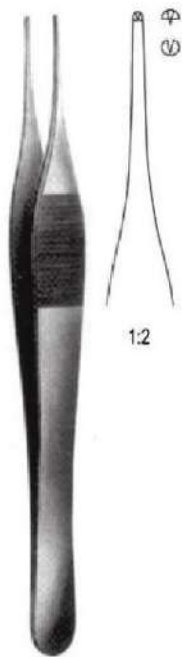

Jefferson
06-1961-18 18.0cm

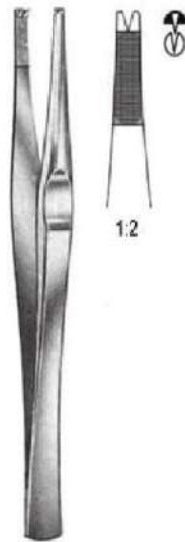

Lanes
06-1962-12 12.5cm
06-1962-15 15.0cm
06-1962-18 18.0cm
06-1962-20 20.0cm

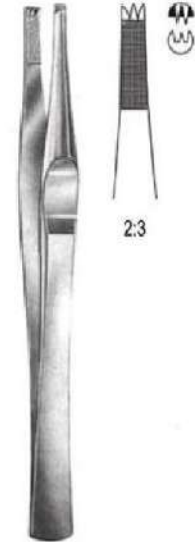

Lanes
06-1963-12 12.5cm
06-1963-15 15.5cm
06-1963-18 18.0cm
06-1963-20 20.0cm

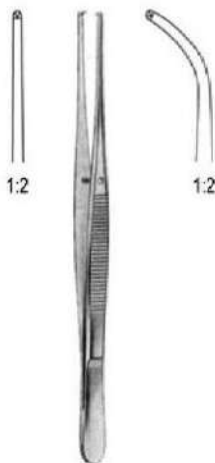

Semken
06-1964-12 12.5cm 06-1965-12 12.5cm
06-1964-15 15.0cm 06-1965-15 15.0cm

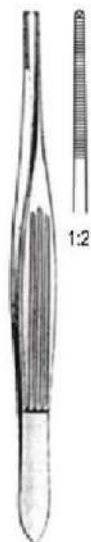

McIndoe

06-1966-15 15.0cm 06-1967-15 15.0cm



Gillies

06-1967-15 15.0cm

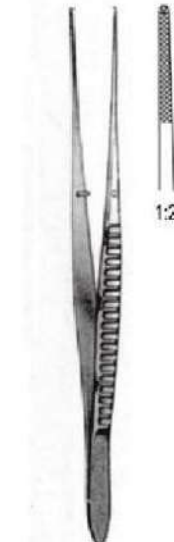

Waugh

06-1968-15 15.0cm
06-1968-18 18.0cm
06-1968-20 20.0cm



Potts Smith

06-1969-18 18.0cm
06-1969-21 21.0cm
06-1969-25 25.0cm
06-1969-30 30.0cm

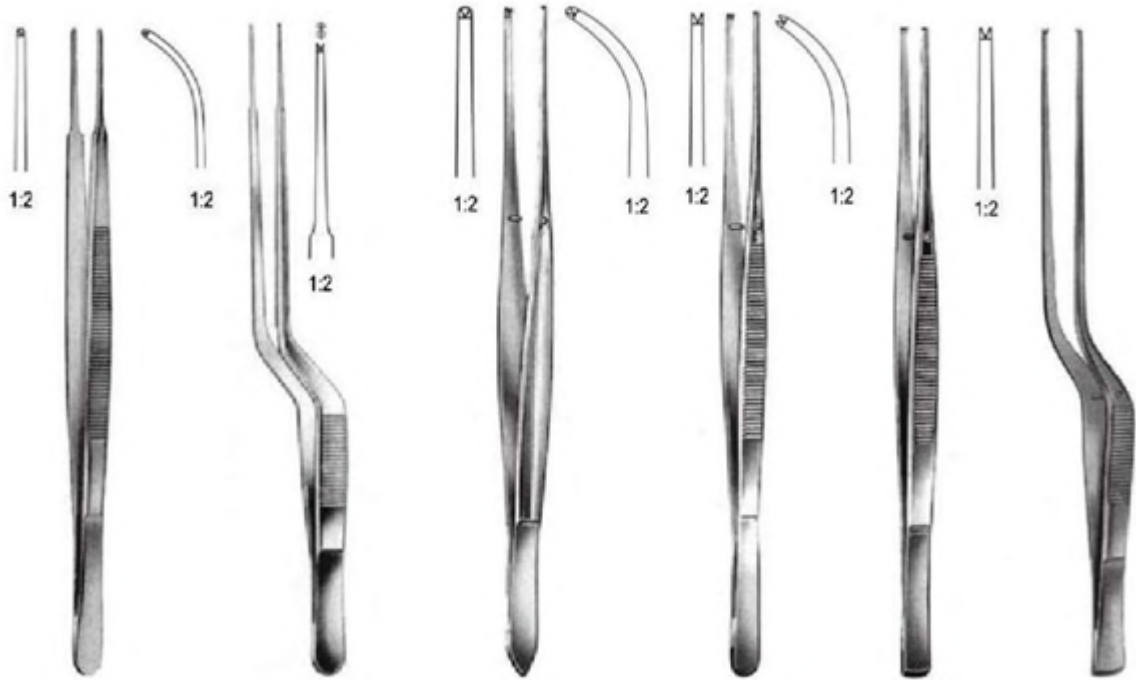

Gerald
06-1970-18 18.0cm
06-1970-18 18.0cm

Gerald
06-1971-18 18.0cm

Cushing
06-1972-17 17.5cm
06-1972-17 17.5cm

Taylor
06-1973-17 17.5cm
06-1973-17 17.5cm

Taylor
06-1974-17
17.5cm

Taylor
06-1975-17
17.5cm



Brown
06-1976-15 15.0cm
06-1976-20 20.0cm
06-1976-25 25.0cm

Graefe
06-1977-10 10.0cm

Stone
06-1978-15 15.0cm

Lerche
06-1979-15 15.0cm

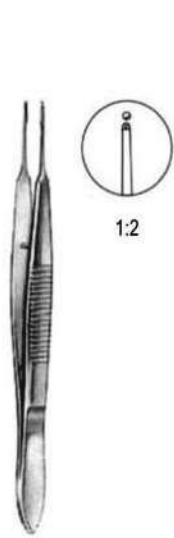

06-1980-11
11.0cm

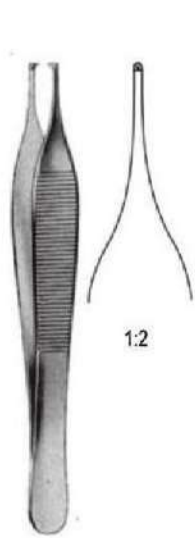

Adson
06-1981-12 12.0cm
06-1981-15 15.0cm

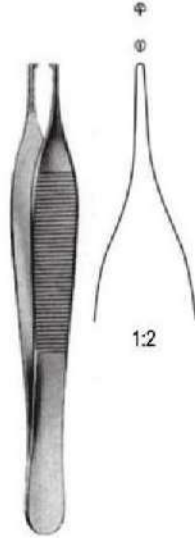

Adson
06-1982-12 12.0cm

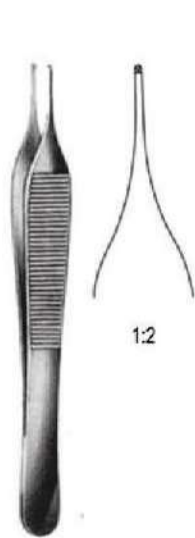

Micro-Adson
06-1983-12 12.0cm



Adson-Brown
06-1984-12 12.0cm



Durante



06-1985-14
14.5cm



06-1985-16
16.0cm



06-1985-20
20.0cm



Russ Modell



06-1986-15
15.0cm



06-1986-20
20.0cm



06-1986-25
25.0cm



Mayo Russ
06-1987-23 23.0cm



Micro Adson
06-1988-12 12.0cm



06-1989-12 12.0cm
06-1989-16 16.0cm

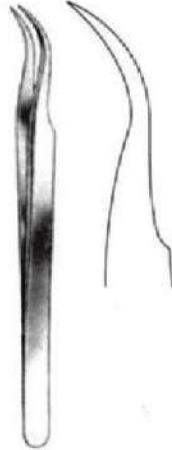

06-1990-12 12.0cm
06-1990-16 16.0cm



10 cm
11.5cm



06-1991-01
06-1991A-01



06-1991-02
06-1991A-02



06-1991-03
06-1991A-03



1:2
06-1992-01
06-1992A-01



1:2
06-1992-02
06-1992A-02



1:2
06-1992-03
06-1992A-03



Yasargil
22.0cm



06-1993-03
3mm Ø



06-1993-05
5mm Ø



Yasargil
22.0cm



06-1994-03
3mm Ø



06-1994-05
5mm Ø



Heifetz
22.0cm



06-1995-03
3mm Ø



06-1995-05
5mm Ø



06-1996-09 09.0cm
06-1996-10 10.5cm
06-1996-11 11.5cm
06-1996-12 12.0cm



06-1997-09 09.0cm
06-1997-10 10.5cm
06-1997-11 11.5cm
06-1997-12 12.0cm



06-2000-18

Gomel
18.0cm



1:2



06-2001-18



06-2002-01

06-2002-02

22.5cm



06-2003-01

06-2003-02

06-2003-03

18.5cm



06-2004-16

15.5cm

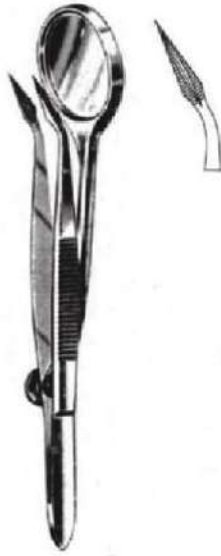

06-2005-12
12.0cm



Feilchenfeld



06-2006-07
7.5cm



06-2006-09
9.0cm



06-2006-20
11.5cm



06-2007-12
12.5cm



06-2008-10



Hunter
10.5cm



06-2009-10



06-2010-10



Walter-Carmalt
10.5cm



06-2011-10

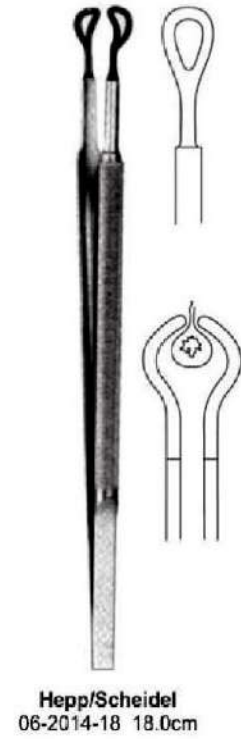
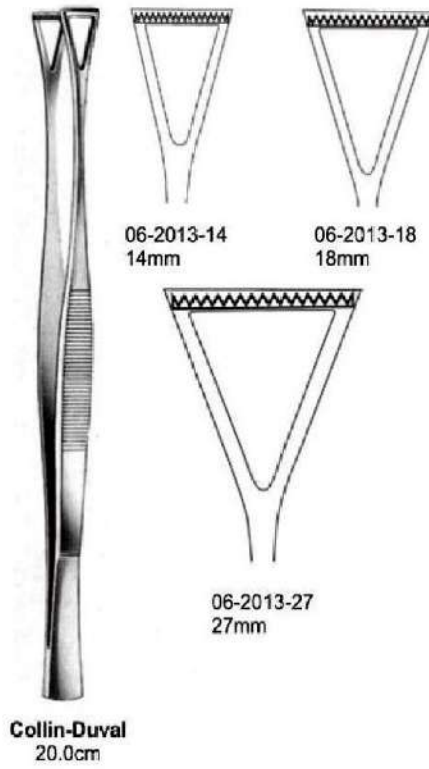



Beer
06-2018-09 9.0cm



Littauer
06-2019-08 8.5cm



06-2020-09 9.0cm



Douglas
06-2021-09 9.0cm



Douglas
06-2022-09 9.0cm



Barraquer
06-2023-10 10.5cm



Gradle
06-2024-09 9.5cm



Henry
06-2025-12 12.0cm



Standard
06-2032-14 14.5cm/5 3/4"
06-2032-16 16cm/6 1/4"
06-2032-18 18cm/7"
06-2032-20 20cm/8"
06-2032-25 25cm/10"



Adson
06-2033-12 12cm/4 3/4"
06-2033-15 15.5cm/6"



McIndoe
06-2034-15
15cm/6"



Semken
06-2035-12 12cm/4 3/4"
06-2035-15 15cm/6"



06-2036-18
18cm/7"



Cushing
06-2037-18
18cm/7"



Cushing-Taylor
06-2038-18
18cm/7"



Grunwald
06-2039-18
18cm/7"



Wangensteen
06-2040-15 15cm/6"
06-2040-23 13cm/9"
06-2040-25 25cm/10"



06-2041-15 15cm/6"
06-2041-18 18cm/7"
06-2041-20 20cm/8"
06-2041-23 23cm/9"
06-2041-25 25cm/10"



Oehler
1:2
06-2042-14 14.5cm/5 1/2"
06-2042-16 16cm/6 1/4"
06-2042-18 18cm/7"
06-2042-20 20cm/8"
06-2042-25 25cm/10"
06-2042-30 30cm/12"

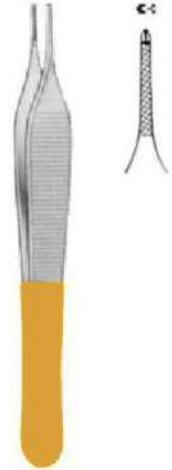

Micro-Adson
06-2043-12 12cm/4 3/4"
06-2043-15 15.5cm/6"



Standard-Adson
06-2044-12 12cm/4 3/4"
06-2044-15 15.5cm/6"



Adson-Brown
06-2045-12
12cm/4 3/4"



Gillies
06-2046-15
15 cm/6"



Tuebingen
16-4658-10
10 cm/4"



16-4659-08
8.5 cm/3 1/2"



Paufigue
16-4660-10
10 cm/4"



Barraquer
16-4661-10
10.5 cm/4 1/4"



McPherson
16-4662-10
10 cm/4"



McPherson
16-4663-07
7.5 cm/3"



McCullough
16-4664-09
9.5 cm/3 3/4"



McCullough
16-4665-09
9.5 cm/3 3/4"



Bonaccito
16-4666-10
10 cm/4"



Bonaccito
16-4667-10
10 cm/4"



16-4668-11
11 cm/4 1/2"



11 cm/4 1/2"

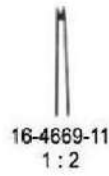

16-4669-11
1 : 2



16-4670-11
2 : 3



16-4671-01



16-4672-02

Nugent
10 cm/4"

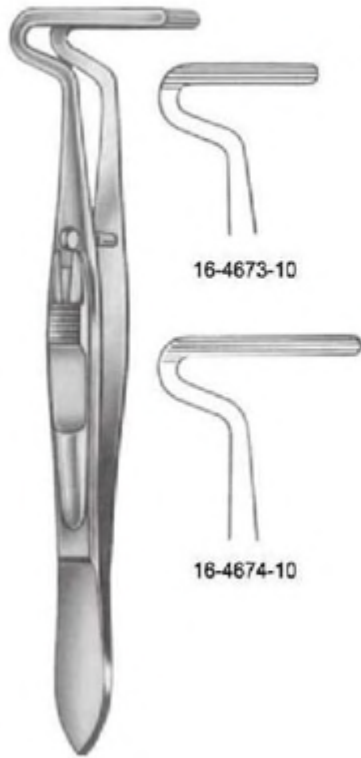

16-4673-10

16-4674-10

Berke
10 cm/4"



Blascovics
16-4675-09
9 cm/3 1/2"



Blascovics
16-4676-09
9 cm/3 1/2"



Worth
16-4677-10
10 cm/4"



Worth
16-4678-10
10 cm/4"



Jameson
16-4679-10
10 cm/4"



Jameson
16-4680-10
10 cm/4"



Prince
16-4681-10
10 cm/4"



Prince
16-4682-10
10 cm/4"



Snellen
16-4683-10
10 cm/4"



Snellen
16-4684-10
10 cm/4"



Erhardt
16-4685-09
9 cm/3 1/2"

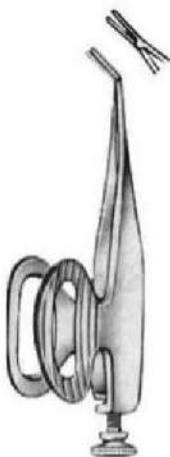

Barraquer
16-4686-05
5.5 cm/2 1/4"

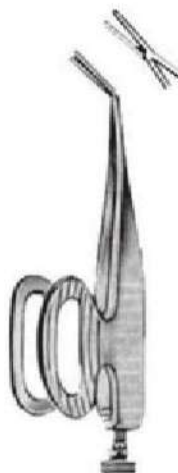

Barraquer
16-4687-07
5.5 cm/2 1/4"

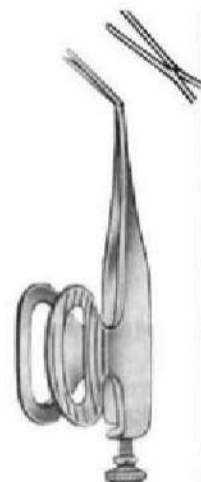

Barraquer
16-4688-10
5.5 cm/2 1/4"

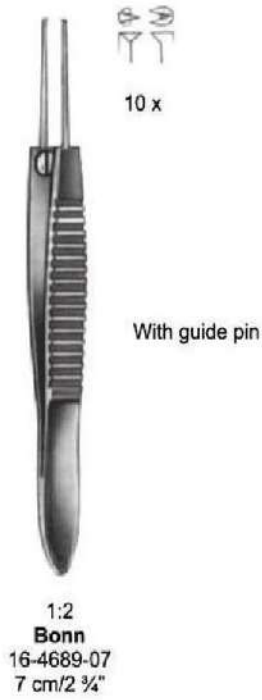



Graefe
10 cm/4"



16-4696-10



16-4697-10



16-4698-10



16-4699-10



16-4700-10



16-4701-10

Conjunctival forceps



Stevens
10.5 cm/4 1/4"



16-4702-10



16-4703-10



16-4704-10



16-4705-10



16-4706-10



16-4707-10



O'Connor
16-4708-10
10 cm/4"



Stevens
16-4709-11
11 cm/4 1/2"



Stevens
16-4710-11
11 cm/4 1/2"



Fischer
16-4711-07
7 cm/2 3/4"

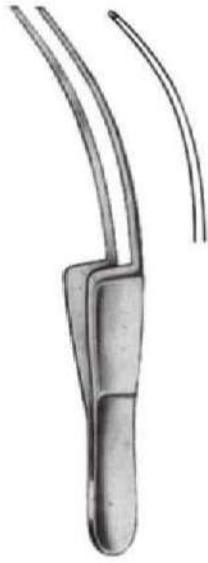

Fischer-Arit
16-4712-07
7 cm/2 3/4"



Hess
16-4713-07
7 cm/2 3/4"



Hess
16-4714-07
7 cm/2 3/4"



Smooth **Chandler** Serrated
16-4715-01 7 cm/2 3/4" 16-4716-02



Fuchs
16-4717-07
7 cm/2 3/4"



Gill-Hess
16-4718-07
7.5 cm/3"



Gill-Hess Teeth Below
16-4719-07 16-4720-07
7.5 cm/3"
Teeth on side



Barraquer-Katzin
(Colibri)
16-4721-07
7 cm/2 3/4"



Fuchs
16-4722-07
7 cm/2 ¾"



Kalt
16-4723-10
10 cm/4"



Terson
16-4724-09
9.5 cm/3 ¾"



Arruga-Nizetic
16-4725-10
10 cm/4"



Castroviejo
16-4726-10
10 cm/4"



Castroviejo
16-4727-10
10 cm/4"



Elsnig
16-4728-10
10 cm/4"

For Len Implantation



Binkhorst
16-4729-07
7 cm/2 ¾"



Arruga
16-4730-09
9.5 cm/3 ¾"



Arruga
16-4731-09
9.5 cm/3 ¾"



Knapp
16-4732-11
11 cm/4¼"



Ayer
16-4733-09
9 cm/3½"



Ayer
16-4734-09
9 cm/3½"



Lambert
16-4735-09
9 cm/3½"



Desmarres
9 cm/3½"



16-4736-01



16-4737-02



16-4738-03



Waugh Dissecting Forcep
20-5402-20
1 x 2 teeth
20cm/8"



Waugh Dissecting Forcep
20-5403-20
serrated
20cm/8"



P.O.Box # 1760,

Head Office: Rodas Road, Sialkot, 51310-Pakistan.

Factory: Golo Phala, Wazirabad Road, Ugoki, Sialkot, 51310-Pakistan.

Workshop: Roras Road, Muzafferpur, Sialkot, 51310-Pakistan.

Tel: + 92 (52) 325 5430 / Fax: + 92 (52) 356 2100

Email: info@nst-zone.pk / sajidmirza_zone@yahoo.com

Web: www.nst-zone.com.pk

